

# CHEMICAL

## CATALOGUE



# Vision

To be a growth company focused on continuously improving customer experience through people, products and processes while making a positive impact on society and the environment.

## GIVE MEANING TO YOUR CLEANING

The Dustbane team is excited to build on its legacy of social and environmental responsibility. On November 5th, 2019 we launched our Give Meaning to Your Cleaning™ Initiative. This represents a strengthened commitment to delivering high quality products and customer service excellence, while making responsible, sustainable choices for our planet and giving back to people in our communities.

We believe that our employees, partners, and customers want to work with organizations that are doing right by our planet and its people, while helping them solve a business problem.

Dustbane is also committed to taking action on climate change. An easy and impactful way to combat climate change is by planting trees. Restoring destroyed forests is one of the keys to healing the planet and maximizing nature's ability to tackle global warming.

Our latest initiative promises to plant a tree for each eligible 4 L ECOLOGO® certified hard surface cleaner sold. With your help, our goal is to plant 1 million trees by 2025.



### **CUSTOMER INTIMATE**

Meet customer expectations.



### **EXECUTE**

Deliver results.



### **GROWTH**

Be a high growth company where staff also grow professionally.



### **RESPECTFUL & INCLUSIVE**

Show all stakeholders respect. Communicate effectively and listen to learn from others.



### **MEANING**

Positively impact people and the planet.

# Table of Contents

UL ECOLOGO®	4
Strippers	7
Sealers	8
Neutralizers	9
Maintainers	9
Finishes	10
Cleaners	14
Disinfectants	16
Degreasers	18
Carpet Care	22
Personal Care	24
Washroom Care	26
Acid Cleaners	27
Odour Control	28
Specialty Products	32
Ready-to-Use Products	34
Proportioning/Dispensing Systems	36
ModularFlex Series	38
Cleaning Tools	42

## Legend

-  WHMIS controlled product
-  CFIA approved
-  Product with DIN
-  Dilute in hot water
-  Best
-  Better
-  Good
-  Part of "Buy 1 – We Plant 1"

# ECOLOGO® Certified Products

Dustbane offers a complete line of products that are tough on dirt and easy on the planet. We create better products in a more environmentally responsible way. UL Environment provides independent, 3rd party credible validation of green marketing claims. Upon validation, UL Environment recognizes sustainable products by bringing trusted transparency to the green marketplace.



Format	Code	Qty
4 L	50201	4

**Azure**  
All-Purpose Surface & Glass Cleaner

A surface cleaner that delivers exceptional performance, while being also an ideal choice for glass surfaces.

Format	Code	Qty
4 L	53761	4

**Bio-Bac Free**  
Fragrance-Free Multi-Purpose Cleaner

Yielding multiple applications with simple dilutions, Bio-Bac Free offers the ideal cleaning solution for floors, windows, stainless steel, restroom surfaces, and even textiles, reducing your product inventory.

Format	Code	Qty
4 L	53762	4

**Bio-Bac II**  
Bio-Based Cleaner, Degreaser and Deodorizer

A blend of surfactants and bio-cleaning agents that provides a revolutionary cleaning solution. Penetrates hard surfaces to remove organic soils in a safer and more efficient way.

Format	Code	Qty
1 L	50247	4
4 L	50248	4
20 L	50249	1

**Doodle Buster**  
Graffiti Remover

This high foaming formula provides optimal coverage. Although it's ideal for new and old graffiti stains, it can also be used for hard surface cleaning, degreasing, carpet cleaning and removing adhesive residue.

Format	Code	Qty
4 L	53191	4
20 L	53193	1

**Eco-Expert**  
Carpet Cleaner

Works well with all Dustbane spot and stain removers. The blend of very low foaming surfactants will not clog vacuums, and allow recovery tanks to be completely utilized. Contains no phosphates.

Format	Code	Qty
4 L	50206	4
20 L	50208	1
210 L	50209	1

**Emerald**  
Hard Surface Cleaner & Degreaser

Its safe yet powerful formula effectively cuts through grease, oil and heavily soiled surfaces. This biodegradable cleaner/degreaser is solvent free.



**Excelsior**  
General Purpose Hard Surface Cleaner

Offers a cleaning solution with exceptional performance without the use of harsh chemicals. It offers superior cleaning efficiency therefore reducing labour.



**Film Away**  
Neutral Detergent & Ice Melt Remover

A great cleaner combined with a neutralizing feature for ice melter residues. Can also be used as a multitask cleaner and reduces the risk of leaving your floor with an unbalanced pH.



**Foundation ★★★**  
Floor Sealer

Foundation achieves uncommon levels of durability and permanency for total sealer protection for resilient and non-resilient floors. APE and odour free.

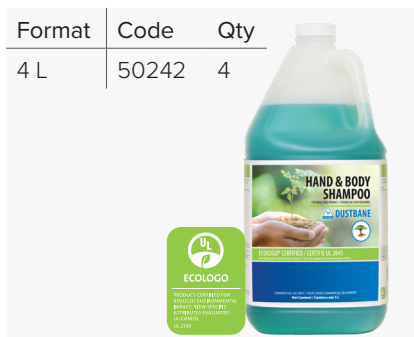

**Hand & Body Shampoo**  
Personal Care Product

Specially formulated for gentle cleaning action. This clear blue-green cleanser has a pleasant fragrance and neutral pH balance. It contains no phosphates, and is APE and VOC free. Mild to the skin.



**Orbit**  
All Systems Floor Finish

Developed for use in high profile areas where the ultimate “wet look” gloss and durability are desired. Its high solid content builds the required film thickness with fewer coats.



**Organic**  
Restroom & Bowl Cleaner

Surfactant-based, this cleaner generates a foam that clings to surfaces to give optimal contact time for a deeper clean. Eliminates rust stains in toilets, urinals, sinks and bathtub



**Oxy D.S.T.**  
Hydrogen Peroxide Based Cleaner

Combines the powerful cleaning and degreasing properties of Dustbane’s Dynamic Surfactant Technology with the amazing stain lifting power of oxygen bleach.



**Oxy-Q**  
Hydrogen Peroxide Based Disinfectant

Utilizes the power of hydrogen peroxide to create a non-toxic, complete cleaning solution: hard surface cleaner, floor cleaner, carpet cleaner, washroom cleaner, degreaser, disinfectant, and deodorizer.



**Polar**  
Cream Cleaner

A multipurpose cleaner that powerfully removes dirt, soap scum, hard water build up, and mineral stains from a multitude of surfaces. Its non-acidic formula eliminates the risk of damage to sensitive materials.

Format	Code	Qty
4 L	50232	4



**Quat Plus**  
Liquid Disinfectant

A disinfectant and germicidal detergent with the cleaning performance of a neutral quat that eliminates odours. Destroys a wide range of bacteria, fungi and viruses without the harsh smell of chemicals.

Format	Code	Qty
4 L	52119	4

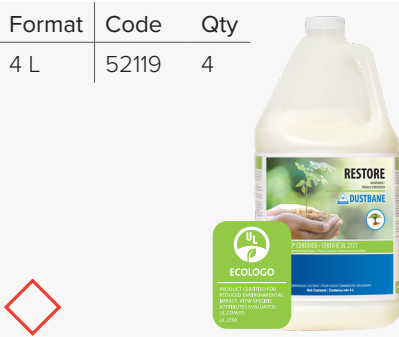

**Restore**  
Maintainer

A triple action floor maintainer for ultra high speed (UHS) maintenance programs which cleans and restores while maintaining an exceptional appearance.

Format	Code	Qty
4 L	50238	4
20 L	50239	1



**Time-Out Plus**  
Floor Stripper

Time-Out Plus' innovative formula is powerful yet environmentally friendly. It cuts through layers of floor finish and sealers quickly and efficiently, with no fumes or odours.

Format	Code	Qty
4 L	50220	4
20 L	50222	1



**Tradition**  
Hand Cleaner

Tradition's emollient containing formula effectively cleans and leaves hands feeling smooth and soft. Use with an open top dispenser in commercial and institutional washrooms, restaurants, hospitality, offices, and schools.

Format	Code	Qty
4 L	50228	4



**Tradition Plus**  
Foaming Hand Cleaner

Tradition's emollient containing formula effectively cleans and leaves hands feeling smooth and soft. The foaming formula reduces the amount of soap dispensed by more than 50%.

Format	Code	Qty
1 L	53346	4
4 L	53347	1
20 L	53348	1



**Vayselle**  
Liquid Dish Cleaner

Concentrated formula and an excellent degreaser. Its neutral pH, biodegradable formula is tough on grease and fat, leaves dishes sparkling clean but is still mild on the hands.

## The ECOLOGO® Difference



**Reduces Single-Use Plastics**  
Less is more! Super concentrates allow for reduced packaging and waste.



**Safe Ingredients**  
No ammonia, no petroleum ingredients, no E-glycol ether, and biodegradable.



**Look For This Symbol!**  
Products featuring our "Buy 1 | We Plant 1" logo plant a tree with each purchase.

# Floor Care

You only get one chance at a first impression. Walking into a health care facility, office, or retail store, what is one of the first things you notice? The floors! Are they clean, clear of debris and scuff marks, or are they dirty and dingy? Floor care is often overlooked but the impact it has on customers and clients is immeasurable.

## Strippers

Over time, floor finishes can wear down and become dirty, and need to be removed before a new one can be re-applied. Floor stripping is all about completely removing old wax, soil and debris found on the floor. Generally it is one of the most labor intensive and time consuming jobs in the professional cleaning industry.

Format	Code	Qty
4 L	52012	4
20 L	52013	1
210 L	52006	1



### Champion ★★★ Powerful Super Stripper

Champion's innovative formula effectively penetrates and power strips floor finish and sealer quickly and efficiently with minimal effort.

Format	Code	Qty
4 L	51999	4
20 L	52001	1
210 L	52002	1



### Formula-1★★ Powerful Floor Stripper

This pleasantly scented powerful floor stripper was developed to penetrate and remove the floor finish build-up quickly and easily with a minimum amount of labour.

Format	Code	Qty
1 L	52005	4



### Champion RTU★ Industrial Degreaser & Baseboard Stripper

Champion's RTU innovative formula effectively cuts through grease, grime floor finish, and oil quickly and efficiently with minimal effort. Ready to use.

Format	Code	Qty
4 L	52007	4
20 L	52009	1



### Dynamite★ Odourless Stripper & Degreaser

An effective stripper that penetrates deeply to remove stubborn sealers, finishes and heavy buildups. A true odourless, fast acting stripper that is ideal for areas with sensitive air quality or involve 24/7 operations.

Format	Code	Qty
4 L	50238	4
20 L	50239	1



### Time-Out Plus Floor Stripper

Time-Out Plus' innovative formula is powerful yet environmentally friendly. It cuts through layers of floor finish and sealers quickly and efficiently, with no fumes or odours.

# Sealers

Floor sealers are able to protect your existing flooring investment from future abrasions, dirt, and improve floor safety. They considerably reduce maintenance costs. One thing to remember, is that floor sealers and floor finishes are not the same products. Sealers are used for building a base before you apply a finish and given their high solids percentage, they exhibit little or no shine. A sealed, unfinished floor will have a dull or matte appearance.

Format	Code	Qty
5 L	53784	4
20 L	53785	1



**Accolade ★★★**  
Floor Sealer & Finish

Seals and finishes in one easy step, providing exceptional gloss and levelling. Specifically formulated to protect both resilient and non-resilient floors.

Format	Code	Qty
4 L	53777	4
20 L	53779	1



**Foundation ★★★**  
Floor Sealer



Foundation achieves uncommon levels of durability and permanency for total sealer protection for resilient and non-resilient floors. APE and odour free.

Format	Code	Qty
5 L	53781	4
20 L	50112	1



**Gard ★★**  
Floor Sealer

Designed as a base coat to protect floors. It boasts superior levels of durability, is detergent resistant and leaves a smooth surface for the application of floor finish.

	RESILIENT VCT/ SHEET VINYL/ RUBBER FLOORS	NATURAL STONE	LOW GLOSS	HIGH GLOSS	NOT BURNISHED	BURNISHED MORE (4-7 TIMES/WEEK)	BURNISHED LESS (ONCE A WEEK)	PREMIUM	VALUE
<b>ALL-SYSTEM / UHS</b>									
Acclamation	△	△		△		△		△	
Elite	△	△		△		△		△	
Endurance	△	△		△			△		
Runway	△	△		△			△	△	
<b>SPRAY-BUFF / DRY-BUFF</b>									
Glacier	△	△		△	△				
Gran-Prix XL	△	△		△			△		
Orbit 	△	△		△			△	△	△
<b>SEALER</b>									
Accolade	△	△		△	△				
Foundation 	△	△	△		△				
Gard	△	△	△		△				△



# Neutralizers

A neutralizer cleaning chemical is anything but neutral. In the cleaning world, a cleaning chemical that is termed a “neutralizer” will most often be acidic, in the pH range of 2. Neutralizers are used to bring alkaline liquids and residues back to a pH of 7 (or neutral), making it simpler to clean up and preparing the surface for the floor finish.

## Maintainers

Floor maintainers can considerably improve cleaning standards and also achieve cost savings. A maintainer is a combination of detergent and wax polymer which cleans, enhances slip resistance, removes black marks and scuffs while building gloss on hard floors.

Format	Code	Qty
4 L	51440	4

**Film Away**  
Neutral Detergent & Ice Melt Remover

A great cleaner combined with a neutralizing feature for ice melter residues. Can also be used as a multitask cleaner and reduces the risk of leaving your floor with an unbalanced pH.

Format	Code	Qty
5 L	53540	4

**Neutralizer**  
Floor Neutralizer & Cleaner

Neutralizer’s effective penetrating action conditions floors by neutralizing and cleaning stripper residues before applying a water emulsion floor sealer or finish.

Format	Code	Qty
5 L	51330	4
20 L	51332	1

**Challenger ★★★**  
UHS Floor Cleaner and Maintainer

Specifically formulated to clean floors maintained with ultra high-speed finishes. A floor finish that stays cleaner longer, reducing the need to strip floors. Works great on finished wood floors.

Format	Code	Qty
4 L	52119	4

**Restore**  
Maintainer

A triple action floor maintainer for ultra high speed (UHS) maintenance programs which cleans and restores while maintaining an exceptional appearance.

Format	Code	Qty
4 L	51952	4

**Cross-Link**  
Spray Buff Maintainer

A spray buff solution used to repair your floor and maintain its high appearance between refinishing. Formulated to restore gloss to tired, worn floors while removing scuff marks and scratches.

# Finishes

Floors act as supporting background for the rest of the room and provide that clean, luxurious look. The look of your flooring can greatly impact the perception that people have of your business. The durability of a floor is also influenced by the amount of wear it will receive. Floor finish creates a hard surface that can withstand wear better than bare flooring.

Format	Code	Qty
5 L	52060	4
20 L	52061	1



**Acclamation ★★**  
All Systems Floor Finish

Fast-drying formula, developed for use in high profile areas where the ultimate wet look gloss and durability are desired.

Format	Code	Qty
5 L	52051	4
20 L	52052	1



**Elite ★★**  
All Systems Floor Finish

Developed for use in high profile areas where the ultimate wet look gloss and durability are desired.

Format	Code	Qty
5 L	52158	4
20 L	52159	1



**Endurance ★★**  
High Durability Floor Finish

Known for its maximum durability and minimal maintenance, it features exceptional gloss, wear and scuff resistance.

Format	Code	Qty
5 L	53935	4
20 L	53936	1



**Glacier ★★★**  
High Solids Floor Finish

A true 25% high solids floor finish. By applying 1 to 2 coats you will get the results of 3 to 4 coats of other floor finishes. This floor finish will save physical energy, labour and will lower maintenance costs.

Format	Code	Qty
5 L	52020	4
20 L	52021	1



**Gran-Prix XL ★★**  
All Systems Floor Finish

Gran-Prix XL is an innovative floor maintenance solution. With its versatile, acrylic copolymer based formula, it's the perfect floor finish for all maintenance systems.

Format	Code	Qty
4 L	52064	4
20 L	52066	1



**Orbit ★★★**  
All Systems Floor Finish

Developed for use in high profile areas where the ultimate "wet look" gloss and durability are desired. Its high solid content builds the required film thickness with fewer coats.

Format	Code	Qty
4 L	52163	4
20 L	52164	1



**Runway ★★★**  
High Durability Floor Finish

A floor finish that offers unbelievable durability. It maintains its exceptional appearance and gloss even in high traffic areas, resists black heel marks, scuffing, powdering, and water damage.

# Floor Finish Chart



Use this chart to compare finishes based on their appearance, durability and application. It will help you choose the best finishes for your maintenance needs.

	RESILIENT/VCT/ SHEET VINYL/ RUBBER FLOORS	NATURAL STONE FLOOR	LOW GLOSS	HIGH GLOSS	NOT BURNISHED	BURNISHED FREQUENTLY (4-7 TIMES PER WEEK)	BURNISHED/LESS FREQUENTLY (ONCE A WEEK)	PREMIUM	VALUE
<b>ALL-SYSTEM / UHS</b>									
Acclamation	△	△		△		△		△	
Elite	△	△		△		△		△	
Endurance	△	△		△		△	△		
Precision	△	△		△		△	△		
Runway	△	△		△		△	△		
<b>SPRAY-BUFF / DRY-BUFF</b>									
Defence	△	△	△		△				△
Glacier	△	△		△		△			
Gran-Prix XL	△	△		△		△	△		
Orbit	△	△		△		△	△		△
<b>SEALER</b>									
Accolade	△	△		△		△			
Foundation	△	△	△						
Gard	△	△	△						△

**IMPORTANT:**

Certain maintenance procedures and products may vary according to type, grade, age and condition of flooring. This chart attempts to give you a general indication of which products will give you the best results. Data subject to change without notice.



Use and wear protective equipment or clothing required by the employer. The use of protective gloves and safety glasses is highly recommended.



Refer to product label and MSDS/SDS before use. For complete product information, please consult [www.dustbane.ca](http://www.dustbane.ca)



# Floor Care In 4 Steps

## Step 1: Floor Preparation

Before proceeding, remove all furniture and roll up all walk-off mats. Sweep the room or vacuum to remove all debris from the floor surface.

Safety is very important during floor maintenance, for both the person doing the cleaning and especially for people walking in the area being cleaned. Slips and falls can happen in a second and can be very dangerous, causing broken bones, head injuries or worse. The proper use of floor signs, as well as following correct cleaning procedures, can reduce the risks of injury. Always wear the appropriate personal protective equipment.

## Step 2: Stripping

When choosing a stripper, the performance is the key factor. Keep in mind that if you buy a cheap or poor quality floor stripper, you might not save money in the long run.

The following factors are important to consider:

- Ease of penetration of the film
- Cost in use
- Odour
- Free-rinsing

	Time-Out Plus	Champion	Formula-1	Dynamite
Level of Performance		★★★	★★	★
Dilution	1:20	1:12	1:10	1:4
pH (1% solution)	10.4	10.9	10.9	12.5
Dwell Time	5-8 minutes	3-5 minutes	3-5 minutes	3-5 minutes
Active Ingredient	Solvent	Solvent	Solvent	Solvent/Caustic
Odour	Odourless	Citrus	Lemon-mint	Odourless
Recommended Neutralizer	Film Away	Film Away	Film Away	Neutralizer



## Step 3: Sealing

When choosing a sealer, just remember the acronym **SAP**:

**Safety:** It must not increase slip potential or emit harmful fumes.

**Appearance:** The higher the gloss level, the greater the degree of color enrichment.

**Performance:** Thickness, durability, and maintenance requirements.

	Foundation	Accolade	Gard
Level of performance		★★★	★★
Coverage	1600 ft <sup>2</sup> to 2500 ft <sup>2</sup> (4 L)	1830 ft <sup>2</sup> to 3014 ft <sup>2</sup> (5 L)	1830 ft <sup>2</sup> to 3014 ft <sup>2</sup> (5 L)
Number of Coats	2-3	2-3	2-3
Drying Time	30-60 minutes	30-60 minutes	30-60 minutes
Solid Contents	16%	20%	15%
Resilient Floors	Yes	Yes	Yes
Non-Resilient Floors	Yes	Yes	Yes

## Step 4: Floor Finish

When comparing floor finish consider these factors:

- Maintenance: Is spray-buffing or burnishing required? If so, how often?
- Ease of removal
- Performance curve
- Appearance of glossiness

	Orbit	Glacier	Gran-Prix XL
Level of performance	★★★	★★★	★★
Coverage	1600 ft <sup>2</sup> to 2500 ft <sup>2</sup> (4 L)	2000 ft <sup>2</sup> to 3200 ft <sup>2</sup> (5 L)	2000 ft <sup>2</sup> to 3200 ft <sup>2</sup> (5 L)
Number of Coats	1-3	1-3	1-3
Drying Time	30 minutes	45 minutes	30 minutes
Solid Content	20%	25%	19%
Resilient Floors	Yes	Yes	Yes
Non-Resilient Floors	Yes	Yes	Yes
Burnishing	Yes	Yes	Yes

View our **Floor Care Training Guide** online for more tips & tricks:



# Hard Surface Cleaners

By maintaining clean surfaces, you'll make sure that the right levels of hygiene in your environment are upheld. Our concentrated chemicals, ready-to-use chemicals, and cleaning wipes feature an array of degreasers, all-purpose cleaners, disinfectants, and sanitizers that can help you achieve more efficient cleaning.



**Azure**  
All-Purpose Surface & Glass Cleaner

A surface cleaner that delivers exceptional performance, while being also an ideal choice for glass surfaces.



**Bio-Bac Free**  
Fragrance-Free Multi-Purpose Cleaner

Yielding multiple applications with simple dilutions, Bio-Bac Free offers the ideal cleaning solution for floors, windows, stainless steel, restroom surfaces, and even textiles, reducing your product inventory.



**Bio-Bac II**  
Bio-Based Cleaner, Degreaser and Deodorizer

A blend of surfactants and bio-cleaning agents that provides a revolutionary cleaning solution. Penetrates hard surfaces to remove organic soils in a safer and more efficient way.



**Excelsior**  
General Purpose Hard Surface Cleaner

Offers a cleaning solution with exceptional performance without the use of harsh chemicals. It offers superior cleaning efficiency therefore reducing labour.

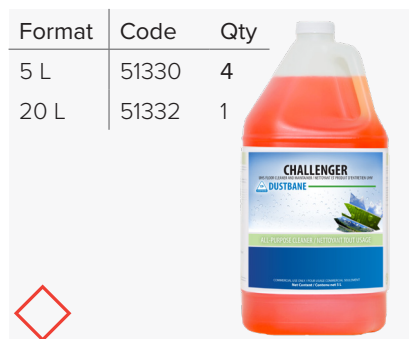

**Challenger ★★★**  
UHS Floor Cleaner and Maintainer

Specifically formulated to clean floors maintained with ultra high-speed finishes. A floor finish that stays cleaner longer, reducing the need to strip floors. Works great on finished wood floors.

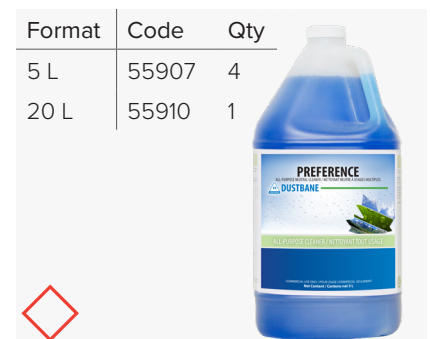

**Preference ★**  
All-Purpose Neutral Cleaner

Everyone loves sparkling clean floors and fresh floral fragrances. This neutral cleaner, with its labour-saving no rinse formula, removes soil but leaves no residue.



**Green Kleen Industr**  
**All-Purpose Detergent**

A multi-use neutral cleaner and degreaser which can also replace many specialty products, thereby drastically reducing inventory and simplifying purchasing requirements.



**Compare ★★**  
**Neutral Detergent**

A versatile, general purpose detergent. Its concentrated formula makes cleaning economical and efficient as only a small amount is required to complete the cleaning task.



**Film Away**  
**Neutral Detergent & Ice Melt Remover**

A great cleaner combined with a neutralizing feature for ice melter residues. Can also be used as a multitask cleaner and reduces the risk of leaving your floor with an unbalanced pH.



**Oxy D.S.T.**  
**Hydrogen Peroxide Based Cleaner**

Combines the powerful cleaning and degreasing properties of Dustbane's Dynamic Surfactant Technology with the amazing stain lifting power of oxygen bleach.



**Nu-Life**  
**Soap Film Remover**

Penetrates and dissolves soap scum, hard water film and other organic residue in showers, bath tubs, toilets and urinals, for easy and effortless removal, without the use of acid cleaners.

## Choosing The Right Products Using The pH Scale

Cleaning is an attempt to neutralise the impact of acidic or alkaline ions in a stain or soiling. So if you wish to clean a soil that is acidic, you should use an alkaline cleaning product, and vice-versa.

Running from 0-14, the pH scale helps you to determine whether a substance is acidic or alkaline. A substance with a pH of 7 is neutral; anything lower than 7 is increasingly acidic, with 0 being the most acidic, and anything higher than 7 is increasingly alkaline, with 14 being the most alkaline.

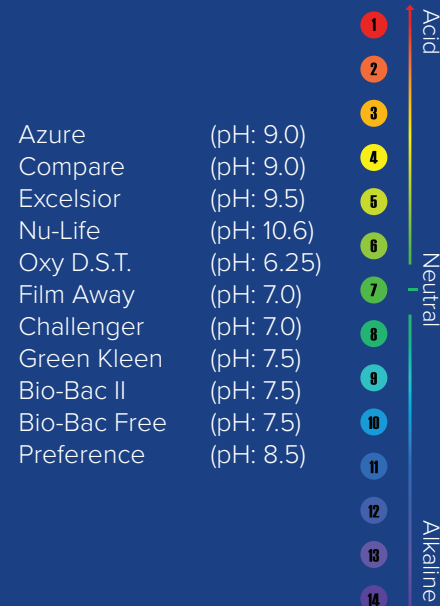

# Disinfectants

Disinfecting vs. sanitizing — what's the difference? The purpose of a sanitizer is to reduce the number of microbes to a safe level, while a disinfectant will completely destroy them.

Format	Code	Qty
4 L	50201	4





**Quat Plus**  
Liquid Disinfectant

A disinfectant and germicidal detergent with the cleaning performance of a neutral quat that eliminates odours. Destroys a wide range of bacteria, fungi and viruses without the harsh smell of chemicals.

Format	Code	Qty
4 L	52880	4
20 L	52881	1





**Oxy-Q**  
Hydrogen Peroxide Based Disinfectant

Utilizes the power of hydrogen peroxide to create a non-toxic, complete cleaning solution: hard surface cleaner, floor cleaner, carpet cleaner, washroom cleaner, degreaser, disinfectant, and deodorizer.

Format	Code	Qty
4 L	52850	4





**HealthGuard**  
One-Step Cleaner Disinfectant and Deodorant

This fast-acting disinfectant with enhanced cleaning powers is safe for all washable surfaces, making it ideal for an everyday, multi-use surface disinfectant.

Format	Code	Qty
5 L	53023	4
20 L	53024	1





**Vanguard ★★★**  
General Purpose Disinfectant Cleaner

This neutral quat-based cleaner is highly efficient in destroying a broad range of bacteria, viruses, fungi, and other microorganisms from hard surfaces. Effectively inhibits the growth of odour-causing mold and mildew.

Format	Code	Qty
5 L	53016	4
20 L	53017	1
210 L	53018	1





**Pinosan ★★**  
General Purpose Disinfectant Cleaner

Offers a powerful cleaning, deodorizing and disinfecting performance. Its neutral quat formula has a broad spectrum of efficacy against bacteria, fungi and viruses and leaves a pleasant pine fragrance.

Format	Code	Qty
1 L	52847	12
4 L	52848	4





**Disinfex**  
Cleaner, Disinfectant and Deodorizer

Achieve optimal disinfection in 5 minutes or less! Delivers fast and effective cleaning and disinfecting performance in the convenience of a ready-to-use formula. viruses, and fungi.



Format	Code	Qty
5 L	53025	4



### Vanguard 256 General Purpose Disinfectant Cleaner

A concentrated version of Vanguard specifically formulated for the healthcare industry. Destroying a broad range of bacteria, viruses, fungi, and other microorganisms from hard surfaces.

Format	Code	Qty
5 L	51440	4
20 L	51349	1
210 L	51350	1



### Triple Action Cleaner, Degreaser & Disinfectant

Triple Action cleans, degreases, and disinfects in one easy step. Reduce your inventory while simplifying your purchasing decision and maintenance program with this 3-in-1 cleaning solution.

Format	Code	Qty
6.55 g x 120	53379	1



### UniTab Disinfectant & Sanitizing Tablets

An effervescent disinfectant and sanitizer tablet that just requires water. Effective against a broad range of microorganisms including *C. difficile* spores, and Hepatitis A.

Format	Code	Qty
4 L	52898	4



### Quatromyicide V Disinfectant, No Rinse Sanitizer, and Deodorizer

A broad-spectrum disinfectant and sanitizer that has been formulated to aid in the reduction of cross-contamination on treated surfaces in areas of prime importance.

## How To Choose The Right Disinfectant

Not all disinfectants do the same job, knowing the difference between each product is a must for proper use of your chemicals. Here's some things to consider when choosing the right disinfectant.

### 1: Know Your Environment

Different surfaces breed different bacteria, viruses, and fungi. Identifying the most common risks for your facility can help determine what disinfectant you may need in order to effectively remove these pathogens.

### 2: Environmental Standards

In this day and age, reducing your ecological footprint isn't as much of a suggestion as much as it is an obligation. While certain cleaning chemicals may generate harsh fumes or contain aggressive ingredients, there are products out there that can help you make better choices for the planet. Products in our ECOLOGO® lineup have undergone rigorous scientific testing, exhaustive auditing, or both, to prove its compliance with stringent, third-party, environmental performance standards.

### 3: Time Management

Contact time is the amount of time that a disinfectant needs to "rest" on a surface in order for it to destroy the microorganisms that are the hardest to kill. Infact, a disinfectant with certain bacteria and virus claims may not meet all of the claims if the contact time isn't met.

### 4: Multi-Purpose or Single Purpose

Some disinfectants are simply, just disinfectants. Although having a product that's tailored to one task is important for certain types of cleaning, it could also become a tedious task for facilities that would require extra products to get the job done.



# Degreasers

Have you ever wondered how degreasers work? It's all about chemistry! Degreaser is alkaline (base) and grease is acidic. Degreaser neutralizes the pH of the grease, causing it to fall apart (dissociate) and be more easily wiped up. We offer two types of degreasers for both industrial applications and the food industry.

Format	Code
4 L	51284
20 L	51285
210 L	51060



**Green Kleen Industrial**  
Powerful Industrial Degreaser

Premier industrial degreaser designed for heavy-duty applications. Eliminates grease, oil, and grime from machinery surfaces, industrial tools, automotive parts, floors, and even carpets.

Format	Code
4 L	51413
20 L	51414
210 L	51415



**Complex Orange**  
Degreaser

Solvent-free cleaner degreaser that quickly emulsifies and removes the toughest dirt and soils.

Format	Code
4 L	53514



**Orang-A-Tang**  
Multi-Use Solvent

A powerful citrus solvent that is effective on a wide range of spots and soils, including gum and tar as well as oil and grease.

Format	Code
5 L	53209
20 L	50142
210 L	53211



**Resolve**  
Cleaner & Degreaser

An A.P.E. and butyl-free cleaner and degreaser recommended for use on any washable surface where dirt, grease and oily residue become a problem.

Format	Code
4 L	51359
20 L	51362
210 L	51363



**Power Lift**  
Industrial Degreaser

An industrial grade degreaser highly effective to quickly remove grease, oil, dirt and grime. Offers a performance superior to solvent based cleaners while being safe on all metal and non-metal surfaces, including rubber.

Format	Code
4 L	51369
210 L	51371



**Power Wash**  
Pressure Wash Concentrate

An effective cleaner and degreaser designed for the truck and transportation industry, that works quickly with minimal effort. Its foaming formula allows for a prolonged dwell time to loosen dirt, grease and oil.

Format	Code
4 L	51433
20 L	51435



**Clearinse**  
Foaming Cleaner & Degreaser

Primarily designed for areas controlled and inspected by health and safety organizations (e.g. Meat, poultry, and fish processing plant). Can also be used in many other applications.

Format	Code
5 L	51440
20 L	51349
210 L	51350



**Triple Action**  
Cleaner, Degreaser & Disinfectant

Triple Action cleans, degreases, and disinfects in one easy step. Reduce your inventory while simplifying your purchasing decision and maintenance program with this 3-in-1 cleaning solution.

Format	Code
5 L	51338
20 L	51339
210 L	51340





**Surface Kleen Plus**  
Cleaner & Degreaser

A highly effective all-purpose cleaner and degreaser, specifically formulated for food industry. Its safe yet powerful formula easily cuts through grease, oil and soils.

Format	Code	Qty
4 L	53761	4





**Bio-Bac Free**  
Fragrance-Free Multi-Purpose Cleaner

Yielding multiple applications with simple dilutions, Bio-Bac Free offers the ideal cleaning solution for floors, windows, stainless steel, restroom surfaces, and even textiles, reducing your product inventory.

Format	Code	Qty
4 L	53762	4





**Bio-Bac II**  
Bio-Based Cleaner, Degreaser and Deodorizer

A blend of surfactants and bio-cleaning agents that provides a revolutionary cleaning solution. Penetrates hard surfaces to remove organic soils in a safer and more efficient way.

Format	Code	Qty
4 L	50206	4
20 L	50208	1
210 L	50209	1









**Emerald**  
Hard Surface Cleaner & Degreaser

Its safe yet powerful formula effectively cuts through grease, oil and heavily soiled surfaces. This biodegradable cleaner/degreaser is solvent free.

Format	Code
750 mL	53220
5 L	53215

**Power Kleen**  
Cleaner & Degreaser

A non-butyl water-based cleaner and degreaser intended for use on any surface where grease and oil residue are a problem. It gives the end users an alternative to butyl-based products.

**Degreaser Chart**

	Emerald	Triple Action	Power Kleen	Complex Orange	Orang-A-Tang	Power Lift	Power Wash	Resolve	Clearinse	Surface Kleen Plus	Bio-Bac II / Bio-Bac Free
AGRICULTURE CANADA APPROVED	△	△	△	△				△	△	△	
ALUMINUM			△								
CARBON	△	△	△	△		△	△	△	△	△	
CANDLE WAX					△						
COOKING EQUIPMENT	△	△	△	△	△			△	△	△	△
CONCRETE FLOORS (GREASY)	△	△	△	△		△	△	△	△	△	
COPPER-BRASS											
COUNTERTOPS & TABLES	△	△		△	△			△		△	
FLOORS	△	△	△	△		△		△	△	△	△
FURNITURE											
GLASS & MIRROR											
GLUE REMOVAL					△						
GREASE & OIL	△		△	△	△	△	△	△	△	△	
GRILL & FRYER	△	△	△	△				△		△	
GUM					△						
INK & MARKER STAINS					△	△		△			
MACHINERY & ENGINES	△	△	△	△	△	△	△	△	△	△	
METAL	△	△	△	△	△	△	△	△	△	△	
PLASTIC SURFACES	△	△	△	△	△			△	△	△	△
PAINT REMOVAL (FRESH)					△						
PLEXIGLASS											
RUBBER	△	△	△	△				△	△	△	
SOOT											
STAINLESS STEEL											
TAR					△	△					
TIRE, HEEL MARKS, WHITE WALLS		△	△	△	△	△	△		△	△	
VINYL	△	△	△	△		△		△	△	△	△
WALLS	△	△	△	△		△		△	△		△
WOODWORK	△	△	△					△			

# Foodservice

Foodservice establishments must be vigilant in adhering to sanitary standards to avoid any type of cross-contamination or outbreaks of foodborne illnesses. Every aspect of the facility must be properly cleaned to ensure safe food preparation and handling. Maintain your reputation as a hygienic establishment!

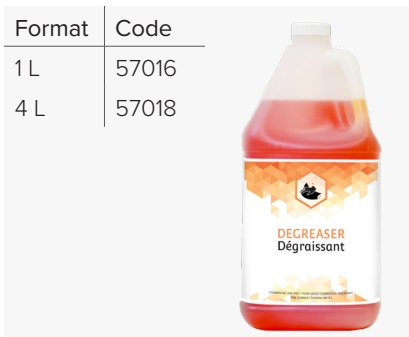

## Degreaser

A powerful degreaser that effectively dissolves any dirt, grease or oil stains. Excellent for floors, painted walls, woodwork, ceramic tiles or metal. Contains no solvents.



## Dish Detergent

A perfect mix of detergents and foam boosters are utilized in this hand dishwashing liquid, making it tough on grease but mild on hands, while providing lasting foam and leaving no film residue on dishes.



## Foaming Hand Soap

With its luxurious lather, this ecological liquid hand soap removes dirt and rinses clean, leaving skin feeling clean and soft.



## Glass Cleaner

A glass and surface cleaner with no scent that leaves no residues. Dissolves dirt on glass surfaces, mirrors, vinyl, plastic, Plexiglass, stainless steel, chrome, and counters.



## Grill & Oven Cleaner

Powerful grill and oven cleaner that clings to surfaces and allows optimal contact time to cut through baked-on food, grease, fat, oil, and carbonized residue from metal cooking surfaces.



## San-Kleen

A sanitizer for use in a third sink for cleaning dishes, glasses, utensils, cutting boards and any other surfaces that frequently come into contact with food.



PROVEN PERFORMANCE.  
EASE OF USE. PEACE OF MIND.



## FOOD SAFETY COMES FIRST!

Growing consumer awareness of food safety and the need to achieve the highest level of clean has become an important focus for many establishments. From the front of the house to back, we understand the importance of a clean and healthy environment for both your patrons and your employees.

### The Facts

- In Canada, more than **4 million cases** of foodborne illnesses occur every year.
- Health Canada estimates that the annual cost related to foodborne illnesses and related deaths, is between **12 and 14 billion dollars**.
- Over **75%** of illnesses can be traced to improper food handling.
- Each year, over **3 million** foodservice employees and over **1 million** patrons are injured in slip & fall accidents.

### The Repercussions

- Damaged reputation.
- Negative media exposure.
- Lawsuits and legal fees.
- Insurance premiums.
- Employees missing work.
- The average cost of a slip & fall accident claim is **\$4000** for employees and over **\$60,000** for patrons.



# Carpet Care

Carpet serves as a “sink” or collection point for everything that is tracked in or settles out of the air and can be tricky to clean. Carpet and hard floors require the same basic level of care and the same basic steps.

Spots and spills should be attended to quickly, and regular cleaning should be performed on both. Both require a comprehensive program to ensure the best appearance and cleanliness.

Format	Code	Qty
4 L	53191	4
20 L	53193	1



**Eco-Expert**  
Carpet Cleaner

Works well with all Dustbane spot and stain removers. The blend of very low foaming surfactants will not clog vacuums, and allow recovery tanks to be completely utilized. Contains no phosphates.

Format	Code	Qty
4 L	53761	4

**Bio-Bac Free**  
Fragrance-Free Multi-Purpose Cleaner

Yielding multiple applications with simple dilutions, Bio-Bac Free offers the ideal cleaning solution for floors, windows, stainless steel, restroom surfaces, and even textiles, reducing your product inventory.

Format	Code	Qty
4 L	53762	4

**Bio-Bac II**  
Bio-Based Cleaner, Degreaser and Deodorizer

A blend of surfactants and bio-cleaning agents that provides a revolutionary cleaning solution. Penetrates hard surfaces to remove organic soils in a safer and more efficient way.

Format	Code
4 L	53759

**Oxy D.S.T.**  
Hydrogen Peroxide Based Cleaner

Combines the powerful cleaning and degreasing properties of Dustbane’s Dynamic Surfactant Technology with the amazing stain lifting power of oxygen bleach.

Format	Code
5 L	53156

**De-Foam**  
Foam Suppressor

Formulated to rapidly break up foam, and to maximize the performance of your equipment. It prevents foam from forming in wands and hoses. An excellent additive for parts washing machines.

Format	Code
5 L	53042

**Dri-Foam**  
Rotary Carpet & Upholstery Shampoo

Designed for rotary style shampooing using a floor machine and nylon brush.

Format	Code	Qty
4 L	52880	4
20 L	52881	1

**Oxy-Q**  
Hydrogen Peroxide Based Disinfectant

Utilizes the power of hydrogen peroxide to create a non-toxic, complete cleaning solution: hard surface cleaner, floor cleaner, carpet cleaner, washroom cleaner, degreaser, disinfectant, and deodorizer.

# All About Spots

## Category A Spots: Water-Based Spots

Product recommended: **Eco-Expert / Oxy D.S.T.**

1. Blot with a clean white towel to remove excess liquid. Rinse towel thoroughly with clean water. Using a trigger sprayer, apply diluted spotter to spot. Gently agitate towards the center and allow dwell time. Blot to remove liquid. Do not rub! Rinse with clear water to remove any residue and blot excess moisture. Repeat if needed.

## Category B Spots: Oil-Based Spots

Product recommended: **Orang-A-Tang**

1. Follow procedure for "Category A Spots" using Eco-Expert or Oxy D.S.T.
2. Apply solvent cleaner sparingly to a clean white towel and apply to spot. Gently agitate. Blot to remove excess liquid then rinse thoroughly with clean water. Blot dry.

## Category C Spots: Coffee and Tea Based Spots

Product recommended: **Oxy D.S.T.**

1. Blot to remove excess liquid. Rinse towel thoroughly with clean water. Using a trigger sprayer, apply diluted spotter to spot. Gently agitate towards the center and allow dwell time. Blot to remove liquid. Do not rub! Rinse with clear water to remove any residue and blot excess moisture.

## Category D Spots: Biological Spots

Product recommended: **Bio-Bac II / Bio-Bac Free**

1. Before proceeding, remove any solids from carpet.
2. Blot to remove excess liquid. Rinse towel thoroughly with clean water. Using a trigger sprayer, apply diluted spotter to spot. Gently agitate towards the center and allow dwell time. Blot to remove liquid. Do not rub! Rinse with clear water to remove any residue and blot excess moisture.

Type Of Spot	Spot Category
Alcoholic Beverage	A
Beer	A
Bleach	A
Blood	D
Butter	B
Calcium Chloride (Ice Melt)	A
Candle Wax	B
Candy	A
Carbon	B
Chewing Gum	A
Chocolate	A
Coffee	C
Cola and Soft Drinks	A
Cosmetics	B
Egg	A
Fruit Juice	A
Glue	B
Grass	A
Gravy and Sauces	B
Ink (Ball Point/Permanent)	B
Ketchup	A
Lipstick	B
Mildew/Mold	A
Milk	A
Mustard	A
Nail Polish	B
Oil, Grease (Including Cooking Oils)	B
Paint (Latex)	A
Paint (Oil)	B
Rust	B
Salad Dressing	B
Shoe Polish	B
Soot	B
Tea	C
Tomato (Sauce/Paste)	A
Urine	D
Vomit	D
Wine	A

View our **Carpet Care Training Guide** online for more tips & tricks:



# Personal Care

Hand washing is like the “do it yourself” vaccine. Proper hand washing is not only hygienic, but it is the single most effective way to prevent the spread of infections in all settings – from the workplace and home to childcare facilities and hospitals, and will help you stay healthy. You carry millions of microbes on your hands. While most of them are harmless, you do attract some that can cause illnesses, such as colds, flu, and diarrhea. Germs can be spread by simple person to person contact or by touching a contaminated surface or object and then touching your face.

Hand washing can greatly reduce the chance of spreading or getting germs. The mechanical action of scrubbing loosens up the dirt and microbes on our hands and the soap picks them up and binds to them so that the water can wash them away. The use of gloves is not a substitute for hand washing.

Many people would agree that washing your hands on a regular basis is essential to reduce the spread of common illness, especially during cold and flu season. Easily accessible soap is the perfect way to remind people to wash their hands.

## Hand Cleaners



### Corsage Pink Hand Soap

Moisturizes and softens hands while cleaning. A pleasure to use because of the rich lather and pleasant fragrance.



### Hand & Body Shampoo Personal Care Product

Specially formulated for gentle cleaning action. This clear blue-green cleanser has a pleasant fragrance and neutral pH balance. It contains no phosphates, and is APE and VOC free. Mild to the skin.



### Tradition Hand Cleaner

Tradition's emollient containing formula effectively cleans and leaves hands feeling smooth and soft. Use with an open top dispenser in commercial and institutional washrooms, restaurants, hospitality, offices, and schools.



### Tradition Plus Foaming Hand Cleaner

Tradition's emollient containing formula effectively cleans and leaves hands feeling smooth and soft. The foaming formula reduces the amount of soap dispensed by more than 50%.





Format	Code
4 L	51771



**Polypower**  
Industrial Hand Cleaner

A high quality hand cleaner that combines the highly efficient detergency of cosmetic grade surfactants with the deep cleaning action of a pumice while being soft on hands.

Format	Code
4 L	51767



**Ultra Orange**  
Industrial Hand Cleaner

Combining effective surfactants and a natural abrasive, it gently cleans even the most deeply embedded grime, soil and dirt.

Format	Code
Lotion, 900 mL	51703
Foaming, 900 mL	51704



**Soap Dispenser**  
Soap Dispenser

This surface mounted unit can affix to the wall at a convenient height that allows the users to easily access them. Available in three sizes: small, standard, large, to fit the space and usage level of all environment.

Format	Code
Foaming (Soap)	51680
Lotion (Soap)	51681
Spray (Hand Sanitizer)	51682



**Touchless Soap Dispenser**  
Automatic Soap Dispenser

A touchless soap dispenser that allows for effective hand cleaning or sanitizing while avoiding germs or infection by eliminating physical contact with the unit.

Format	Code
Unit	51777



**Industrial Rack**  
Wall Mounted Jug Rack

This tough and durable wall mountable metal dispenser is designed for use in wet or dry environments. It fits 4 L, 4.5 L & 5 L bottles.

Format	Code
Foaming (Black)	51700
Lotion (White)	51701



**Open Top Dispenser**  
Soap Dispenser

Made of tough and durable plastic, these 800 mL dispensers are easy to operate, fill and clean. Ideal for dosing of liquid soaps, lotions and shampoos in washrooms, bathrooms, care and medical rooms, and more.

# Washroom Care

Regardless of your industry or the size of your company, the state of your restroom can make or break a customer's experience. A clean restroom encourages positive feelings in customers about your business. This is because customers can associate the cleanliness of your company's restroom with the cleanliness of your entire business.

Format	Code
1 L	53732
5 L	53734



**Aqua Scrub**  
Multi-Use Cleaner & Polish

This one-step cleaner and polisher has efficient cleaning abilities and a fresh lemon mint scent. An effective acid replacement cleaner that provides a deep cleaning for multiple surfaces.

Format	Code	Qty
4 L	53761	4





**Bio-Bac Free**  
Fragrance-Free Multi-Purpose Cleaner

Yielding multiple applications with simple dilutions, Bio-Bac Free offers the ideal cleaning solution for floors, windows, stainless steel, restroom surfaces, and even textiles, reducing your product inventory.

Format	Code	Qty
4 L	53762	4





**Bio-Bac II**  
Bio-Based Cleaner, Degreaser and Deodorizer

A blend of surfactants and bio-cleaning agents that provides a revolutionary cleaning solution. Penetrates hard surfaces to remove organic soils in a safer and more efficient way.

Format	Code
1 L	53725
5 L	53727



**Hi-Genic ★**  
Non-Acid Washroom Cleaner & Sanitizer

Designed for the daily maintenance, cleaning, sanitizing and deodorizing of toilet bowls, urinals, bathtubs, sinks, shower stalls, and other hard non-porous surfaces.

Format	Code
1 L	51757
5 L	51755



**Blu-Lite Plus ★★**  
Foaming Cleaner, Disinfectant, Descaler & Deodorizer

This surfactant-based cleaner and disinfectant generates a foam that clings to surfaces to give optimum contact time. Provides a deep cleaning of restroom surfaces.

Format	Code
1 L	53747
5 L	53749



**Blu-Lite ★★★**  
Disinfecting Bowl Cleaner

An all-in-one viscous cleaner, disinfectant descaler and deodorizer. An acid replacement cleaner that offers optimal performance. A complete solution for restroom maintenance.

Format	Code	Qty
1 L	53769	4
4 L	53768	4





**Organic**  
Restroom & Bowl Cleaner

Surfactant-based, Organic generates a foam that clings to surfaces to give an optimum contact time for a deeper clean. It deodorizes as it cleans multiple restroom surfaces and eliminates rust stains.



**Oxy D.S.T.**  
Hydrogen Peroxide Based Cleaner

Combines the powerful cleaning and degreasing properties of Dustbane's Dynamic Surfactant Technology with the amazing stain lifting power of oxygen bleach.



**Oxy-Q**  
Hydrogen Peroxide Based Disinfectant

Utilizes the power of hydrogen peroxide to create a non-toxic, complete cleaning solution: hard surface cleaner, floor cleaner, carpet cleaner, washroom cleaner, degreaser, disinfectant, and deodorizer.



**Polar**  
Cream Cleaner

A multipurpose cleaner that powerfully removes dirt, soap scum, hard water build up, and mineral stains from a multitude of surfaces. Its non-acidic formula eliminates the risk of damage to sensitive materials.

# Acid Cleaners

Acid cleaners help break down difficult stains like rust or mineral deposits, and make excellent drain openers. Their formula reacts chemically with the material in the clog, and the reaction releases heat, which is necessary to melt congealed grease.



**Presto ★**  
Disinfectant Bowl Cleaner

An acid-based cleaner that effectively removes rust, stains, scale and hard water deposits instantly. It cleans and disinfects in one easy step. Does not harm plumbing and septic systems.



**Strate Flush ★★**  
Emulsion Bowl Cleaner & Deodorizer

An acid bowl cleaner designed to clean, deodorize, and remove rust and mineral stains in one operation. Does not harm plumbing and septic systems.



**Quick Fix ★★★**  
Viscous Bowl Cleaner

A fast acting bowl cleaner. Its viscous formula adheres to surfaces of the toilet bowl and urinal allowing for deep penetration to remove hard water stains, rust and even stubborn mineral deposits.



**Nitro**  
Liquid Drain Opener

Provides a powerful and fast acting solution for drainage issues as it clears the toughest clogs from any drain quickly. Safe for all septic systems and pipes, including PVC, plastic and old pipes.

View our **Washroom Care Training Guide** online for more tips & tricks:



## Urinal Odour Control

Some urinal designs can cause splashback, in which case a urinal screen with anti-splash feature can become a great way to keep the area around the urinal clean. Using an enzyme-based puck or screen can also help control odours coming from the plumbing.

Format	Code
50 g	53412



### Enviro Block ★★ Water Soluble Deodorant Blocks

Instantly eliminates persistent odours at their source. The Enviro Block chemically combats drain odours to deodorize restrooms urinals.

Format	Code
Herbal Mint	50260
Mango	50262
Cucumber Melon	50264
Spiced Apple	50266
Unscented	50269



### 3D Shield ★★★ Urinal Screen

Its unique post and lattice design eliminates 99% of splashback and installation errors. More than twice the fragrance that the competing urinal screens, the 3D Shield releases beneficial bacteria for over 30 days.

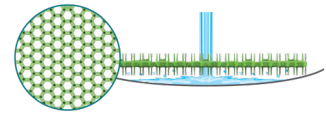

#### 3D Shield

Has more open design, increased height, and does not splash.

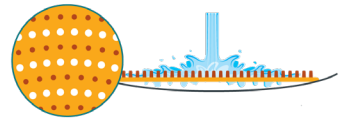

#### Competitor Screens

With fewer openings, they pool liquid, causing splashback and more clean up.

## Proper Maintenance of Men's Public Washrooms

Our senses are always on alert. The first impression we get of any environment is often the most important one. Visible cleanliness and a pleasant fresh smell go a long way in creating a positive impression in restrooms.

Respondents of a recent survey said they believed "bad" washrooms — those with bad smells, clogged or un-flushed toilets and dirty, unkempt or old fixtures — equated to bad management. And at least 93% of respondents believed the condition of a workplace washroom to be an indicator of how a company values its workforce.

## 5 Key Maintenance Areas

### Multi-Purpose Cleaner:

Keep all hard surfaces clean.

### Glass and Chrome Cleaner:

Keep your mirrors, chrome and stainless steel sparkling clean and streak free.

### Hand Cleaner:

Hygienic hand washing practice is encouraged by the use of soap dispensers.

### Urinal Screens:

The use of urinal screens eliminates odour, splash back and bacteria.

### Air Renewal System:

An air renewal system will neutralize airborne odours throughout the room.

# Restroom Cleaning Chart



Cleaner	Bath Tubs	Ceramic Tile	Chrome Fixtures	Copper-Brass	Countertops	Drain Opener	Floors, Walls, Tiles	Grout & Tile	Garbage Pails	Glass, Mirrors	Mildew	Odour	Plastic Surfaces	Plexiglass	Porcelain	Rust	Shower Stalls	Sinks	Hand Soap – Lotions	Hand Soap – Industrial	Soap Film Remover	Stainless Steel	Toilets	Urinals	
<b>AQUA SCRUB</b>	<	<	<	<	<																				
<b>BLU-LITE</b>		<	<	<	<			<					<										<	<	<
<b>BLU-LITE PLUS</b>		<	<	<	<			<					<										<	<	<
<b>HI-GENIC</b>	<																						<	<	<
<b>NITRO</b>																									
<b>PRESTO</b>																									
<b>STRATE FLUSH</b>																									
<b>OXY-Q</b>	<	<	<	<	<			<	<	<	<		<										<	<	<
<b>PINOSAN</b>	<	<	<	<	<			<	<	<	<		<										<	<	<
<b>QUAT PLUS</b>	<	<	<	<	<			<	<	<	<		<										<	<	<
<b>VANGARD</b>	<				<			<	<	<	<		<										<	<	<
<b>AZURE</b>		<	<	<	<			<		<			<										<		
<b>EXCELSIOR</b>		<	<	<	<			<	<	<			<										<	<	<
<b>ORGANIC</b>	<	<	<	<	<			<	<	<			<										<	<	<
<b>ORGANIC BOWL CLEANER</b>	<				<			<	<	<			<										<	<	<
<b>OXY D.S.T.</b>	<				<			<	<	<			<										<	<	<
<b>POLAR</b>	<	<	<	<	<			<	<	<			<										<	<	<
<b>CORSAGE</b>					<																				
<b>POLYPOWER</b>																									
<b>TRADITION</b>																									
<b>TRADITION PLUS</b>																									
<b>COMPARE</b>					<			<					<										<		
<b>NU-LIFE</b>	<	<						<					<										<		
<b>3D SHIELD</b>																									
<b>ENVIRO PUCK</b>		<																							
<b>MAGIC</b>		<																							

NON-ACID CLEANERS

ACID CLEANERS

DISINFECTANTS

UL ECOLOGO CERTIFIED PRODUCTS

HAND CLEANERS

ALL-PURPOSE CLEANERS

OTHER

**IMPORTANT:**  
This quick selection chart attempts to give you a partial overview of products and their applications. Technical data subject to change without notice.



Use and wear protective equipment or clothing required by the employer. The use of protective gloves and safety glasses is highly recommended.



Refer to product label and SDS before use. For complete product information, please consult [www.dustbane.ca](http://www.dustbane.ca).

# Odour Control

The first impression of any environment is often the most important. Visible cleanliness and a pleasant fresh smell create a positive impression of any restroom, change room, office, or other facility..



Format	Code	Qty
4 L	53761	4

**Bio-Bac Free**  
Fragrance-Free Multi-Purpose Cleaner

Yielding multiple applications with simple dilutions, Bio-Bac Free offers the ideal cleaning solution for floors, windows, stainless steel, restroom surfaces, and even textiles, reducing your product inventory.

Format	Code	Qty
4 L	53762	4

**Bio-Bac II**  
Bio-Based Cleaner, Degreaser and Deodorizer

A blend of surfactants and bio-cleaning agents that provides a revolutionary cleaning solution. Penetrates hard surfaces to remove organic soils in a safer and more efficient way.

Format	Code
5 L	51146

**Stink Relief**  
Odour Eliminator

This natural enzyme-based formula destroys odour at its source while being safe to use around people and animals. Non-toxic, non-flammable, hypo-allergenic and biodegradable.

Format	Code
5 L	51017

**Friendly Air ★**  
Air Freshener

An advanced concept in malodour removal that eliminates disagreeable and lingering odours. Safe, non-toxic and nonflammable, it will not stain any material unaffected by plain water.

Format	Code
5 L	51014

**Disappear ★★**  
Malodour Counteractant

Effectively counteracts and eliminates a broad spectrum of unpleasant odours. Its ultra powerful formula makes any undesirable odour disappear quickly without using or leaving an overpowering perfume.

Format	Code
5 L	51144

**Aquascent ★★★**  
Water Soluble Deodorizer

Aquascent's advanced technology utilizes premium natural fragrance oils and unprecedented residual performance to provide a refreshing boost. Can be used as an air freshener or additive in your cleaning solution.



Format	Code
Cotton Blossom	50270
Mango	50272
Cucumber Meon	50274



**Air Flex**  
The “Almost Anywhere” Air Freshener

Freshens while remaining hidden on the side of toilets, inside cabinets, on the underside of trash can lids, and so much more. Freshens for 30 days with 50x more fragrance than standard toilet rimsticks.



Format	Code
Unit	50280



**Air Flex Holder**  
Adhesive Holder for the Air Flex

The holder stays in place with two sided tape while the Air Flex is replaced each month. A fresh smelling area without bulky air freshener.

Format	Code
White dispenser	50298
Black dispenser	50299

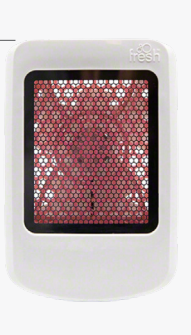

**Ourfresh 2.0**  
Automatic Air Freshener Dispenser

Featuring a sleek updated design, it is an automatic air freshener dispenser that offers a perfect alternative to metered aerosols, ensuring your environment stays fresh and inviting. Fan technology and battery operated

Format	Code
Cotton Blossom	51132
Mango	51133
Cucumber Melon	51131



**Air Max**  
30 Days Passive Air System

Offers consistent and powerful odour control. Designed for a month long performance, it outperforms gels, wicks and aerosols. It fits in any competitor’s holders, even fan-powered dispensers.

Format	Code
Unit	51130



**Air Max Dispenser**  
Passive Air System

With its sleek and elegant design, it is designed to house the Air Max and achieve maximum odour control without the use of any propellants or batteries. Only natural airflow is required to work effectively.

Format	Code
Spiced Apple	50290
Cucumber Melon	50291
Mango	50292
Fabulous	50293

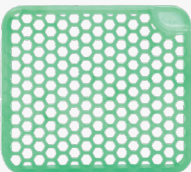

**Ourfresh 2.0**  
Dispenser Refills

100% Recyclable Premium Fragrance Inserts. OurFresh 2.0 Refills release fragrance in a dry format, eliminating the risk of spills, leaks, and unsightly residue. Revitalize your environment day after day for up to 30 days.

## Odour Control Options

Odour management can be a tough task. With a multitude of options to manage odours, it can be overwhelming and confusing to pick the appropriate product for the task.

The first thing to do when tackling odours, is to find the source. Once you have found the source, the next step is to clean the surface. If you are unable to remove the majority of the source of the odour, odour control products can be used. Many products are available, but what’s the difference between an air freshener, an odour counteractant or deodorizer? How do you know which one is best and how do they work? Here’s a quick explanation:

### Deodorizer/Air Freshener

A product that “deodorizes” will mask odours but doesn’t cover the odour permanently — it simply adds a good odour to a bad odour or can give a room a fresh scent if odours are not an issue.

### Odour Counteractant/Eliminator

An air freshener with odour counteracts is the best solution for a facility with offensive odours such as smoke and rotting food that should be removed from the air. They neutralize the malodour by breaking down its molecules in the air.

### Enzyme Based

Enzyme based products attack the contamination, creating enzymes that break down odour-causing matter. Ideal for bio-based odour such as urine that comes from naturally occurring bacteria and uric acid crystals. The great benefit of enzyme based products is that they’ll keep working even after the initial application.

# Specialty Products

Particular situations require special products to complete the cleaning task. Maintaining a pristine environment isn't subject to how often or thoroughly you clean, but rather the type of products you use. Find an assortment of far-reaching cleaning supplies that go the extra mile to deep clean, restore and prevent mess and imperfections around your business, office or restaurant.

Format	Code
340 g	50300



## Super-Sorb Spill Absorbent

High-performance absorbent powder that can absorb spills 60 times its weight immediately and up to 400 times its weight within 2 minutes. Formulated with organic ingredients, it quickly absorbs and neutralizes odours

Format	Code
22 kg	52509
100 kg	52100
135 kg	52135



## Dustbane 100% Biodegradable Sweeping Compound

Use to reduce airborne dirt and dust during sweeping of sealed and unsealed wood, concrete and metal floors. Prevents dust and dirt from becoming airborne when sweeping.

Format	Code
4 L	50201



## Azure All-Purpose Surface & Glass Cleaner

A surface cleaner that delivers exceptional performance, while being also an ideal choice for glass surfaces.

Format	Code
5 L	53709
210 L	53712



## Expo ★★ Window & Glass Cleaner

This eco-friendly liquid glass cleaner leaves glass, windows and mirrors sparkling clean and free of streaks. Designed to clean windows, mirrors, countertops and any washable hard surfaces.

Format	Code
5 L	53682



## Magic ★★★ Window & Glass Cleaner

Leaves glass and mirrors looking their best without any streaks or residue. Easy to use, cuts through dirt and oily film while leaving a fresh and clean scent. Designed to clean windows and any washable hard surfaces.

Format	Code
5 L	55064



## Dish Shine Liquid Dish Detergent

This lemon scented detergent is ideal for hand dishwashing. A perfect mix of detergents and foam boosters are utilized in this hand dishwashing liquid, making it tough on grease but mild on hands, while providing lasting foam.

Format	Code
1 L	53346
4 L	53347
20 L	53348



## Vayselle Liquid Dish Cleaner

Concentrated formula and an excellent degreaser. Its neutral pH, biodegradable formula is tough on grease and fat, leaves dishes sparkling clean but is still mild on the hands.

Format	Code
5 L	53156



## De-Foam Foam Suppressor

Formulated to rapidly break up foam, and to maximize the performance of your equipment. It prevents foam from forming in wands and hoses. An excellent additive for parts washing machines.





### Doodle Buster Graffiti Remover

This high foaming formula provides optimal coverage. Although it's ideal for new and old graffiti stains, it can also be used for hard surface cleaning, degreasing, carpet cleaning and removing adhesive residue.



### Fryer & Griddle Fryer & Griddle Cleaner

Quickly penetrates and emulsifies baked on grease, oil and carbon on metal surfaces, leaving behind a clean and odour-free surface.



### Hygo H<sub>2</sub>O Dust Control Treatment

Used to chemically treat dust mops, Hygo H<sub>2</sub>O traps and holds dust and soil instead of scattering it during the cleaning process. Reduces wear and abrasion by removing sand, dirt and other gritty materials from the floor.

## Aerosols

We offer a range of specialty products in the convenience of an aerosol. None of our aerosols contain C.F.C.



Product	Format	Code	Case Qty.
Air Freshener Citrus	283 g	50160	12
Baseboard Stripper	510 g	50161	12
Chewing Gum Remover	198 g	50163	12
Citrus Air	340 g	50175	12
Graffiti Remover	482 g	50174	12
Magic Glass Cleaner	538 g	50164	12
Oven Cleaner	510 g	50170	12
Stainless Steel Cleaner	396 g	50172	12

# Ready-To-Use Products

Ready-to-use products offer the convenience of cleaning on the go without having to dilute chemicals. Our 750 mL bottles come equipped with a foaming trigger sprayer for ease of use. They're ergonomically designed and feature a natural colour, allowing you to see the quantity of product in the bottle. We also offer ready-to-use, pre-moistened wipes for one-step cleaning.

Format	Code
1 L	51145



**Aquascent RTU**  
Ready To Use Deodorizer

Utilizes advanced technology and premium natural fragrance oils to eliminate unpleasant odours effectively. Removes chemical smells commonly found in cleaning agents, leaving a lasting, pleasant fragrance

Format	Code
750 mL	50202



**Azure RTU**  
All-Purpose Surface & Glass Cleaner

A surface cleaner that delivers exceptional performance, while being also an ideal choice for glass surfaces.

Format	Code
1 L	52847
4 L	52848



**Disinfex**  
Cleaner, Disinfectant and Deodorizer

Achieve optimal disinfection in 5 minutes or less! Delivers fast and effective cleaning and disinfecting performance in the convenience of a ready-to-use formula. viruses, and fungi.

Format	Code
750 mL	50203



**Emerald RTU**  
Hard Surface Cleaner & Degreaser

Its safe yet powerful formula effectively cuts through grease, oil and heavily soiled surfaces. This biodegradable cleaner/degreaser is solvent free.

Format	Code
750 mL	53766



**Oxy D.S.T. RTU**  
Hydrogen Peroxide Based Cleaner

Combines the powerful cleaning and degreasing properties of Dustbane's Dynamic Surfactant Technology with the amazing stain lifting power of oxygen bleach.

Format	Code
750 mL	53220



**Power Kleen RTU**  
Cleaner & Degreaser

A non-butyl water-based cleaner and degreaser intended for use on any surface where grease and oil residue are a problem. It gives the end users an alternative to butyl-based products.

Format	Code
750 mL	52889



**Quatromycide V RTU**  
No Rinse Sanitizer

A neutral quaternary ammonium liquid which is used to sanitize all hard, non-porous surfaces – no rinsing required.

Format	Code
1 L	57012



**Oven and Grill Cleaner RTU**  
Ready To Use

Powerful grill and oven cleaner that clings to surfaces and allows optimal contact time to cut through baked-on food, grease, fat, oil, and carbonized residue from metal cooking surfaces.

Format	Code
1 L	51286



**Green Kleen Industrial RTU**  
Industrial Degreaser

Premier industrial degreaser designed for heavy-duty applications. Eliminates grease, oil, and grime from machinery surfaces, industrial tools, automotive parts, floors, and even carpets.

Format	Code
1 L	52005



**Champion RTU★**  
Industrial Degreaser & Baseboard Stripper

Champion's RTU innovative formula effectively cuts through grease, grime floor finish, and oil quickly and efficiently with minimal effort. Ready to use.

Format	Code
750 mL	51345



**Triple Action RTU**  
Cleaner, Degreaser & Disinfectant

Triple Action cleans, degreases, and disinfects in one easy step. Reduce your inventory while simplifying your purchasing decision and maintenance program with this 3-in-1 cleaning solution.

Format	Code
1 L	53020
4 L	53021



**Vanguard RTU**  
Ready-to-Use Disinfectant Cleaner

Designed to simplify the cleaning and disinfecting process with no PPE required. The same great formula and results you have come to expect from Vanguard in the convenience of a pre-diluted, ready-to-use product.

Format	Code
70 wipes	53380



**Stainless Steel Wipes**  
Water Based Stainless Polishing Wipes

Cleans, polishes, and protects appliances, stainless steel, and other metal surfaces. Water based, streak free formula designed for daily use. Remove smudges, water stains, fingerprints, food spills, grease, and more.

Format	Code
180 wipes	53377



**Eliminate**  
One Step Cleaner, Disinfectant,  
Virucide & Deodorizer

A one-step disinfectant wipe that eliminates 99.9% of contaminants in just 15 seconds and complete disinfection in only 4 minutes. No pre-washing or rinsing required.

Format	Code
100 wipes	53378



**Sanitizing Wipes**  
Food Contact Surface Sanitizing Wipes

Specifically designed to sanitize food contact surfaces. Ideal for use on most hard surfaces where sanitizing is required without a potable water rinse. Kills 99.999% of bacteria on food contact surfaces in 60 seconds.

Format	Code
120 wipes	53376



**Triple Action Multi**  
Cleaner, Degreaser & Disinfectant

Cleans, degreases and disinfects in one simple wipe. Maintaining a clean and sanitary environment has never been so easy.

# ModularFlex Series

Simple, efficient, economical and environmentally conscious, Dustbane's reformulated ModularFlex Series was designed to address all your cleaning needs. We now offer 5 highly versatile products, that will reduce your cleaning footprint. The possibilities for these products are practically limitless, making them the ideal choice.

Format	Code
Unit	HSP9184



## ModularFlex System Proportioning System

Delivers the flexibility to dispense multiple products and to configure the system as it works best for your application.

Format	Code
2 L	50980



## M1 Restroom Cleaner Emulsifying Cleaner

Suitable for toilet bowls, urinals and porcelain. It removes encrustations, scale and stains while keeping toilets bright, clean and smelling fresh.

Format	Code
2 L	50982



## M6 Oxy-Q Hydrogen Peroxide Based Disinfectant

Over 500 applications. 97% of cleaning needs addressed in one bottle. Non-toxic and safer than chlorine bleach. Cleans, degreases, deodorizes and disinfects.

Format	Code
2 L	50984



## M7 Neutral Cleaner Neutral Cleaner & Ice Melt Remover

Reduces slip and fall accidents by eliminating ice melt residue that attracts water. Removes damaging ice melt residue. Neutralize alkaline residue for flawless floor finish application.

Format	Code
2 L	50986



## M8 Glass Cleaner Surface & Glass Cleaner

Suitable for mirrors, glass, porcelain, counters and stainless steel. Removes marks, stains, atmospheric grime and smoke haze. Good for sensitive surface cleaning.

Format	Code
2 L	50990



## M11 Degreaser Hard Surface Cleaner & Degreaser

Cuts through grease, oil, and heavy soiled surfaces. Suitable for the food service and industrial settings. Solvent free, caustic free.



# ModularFlex Cleaning Chart

The ModularFlex System is complete customizable to your specific needs. Up to 4 products can be used at once. Here are your options:



**IMPORTANT:**

Use and wear protective equipment or clothing required by the employer. The use of protective gloves and safety glasses is highly recommended.



Refer to product label and SDS before use. For complete product information, please consult [www.dustbane.ca](http://www.dustbane.ca).

## M1 RESTROOM CLEANER Emulsifying Cleaner

For use on sinks, toilets, chrome and other hard surfaces.

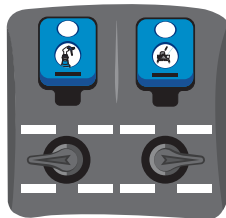

## M6 OXY-Q Hydrogen Peroxide Based Disinfectant

Spray and wipe cleaner for surfaces that require disinfection. For use in auto-scrubber or carpet extractors.

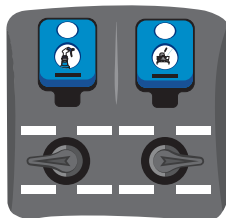

## M7 NEUTRAL CLEANER Neutral Detergent & Ice Melt Remover

For use with mop and bucket or auto-scrubber. Spray and wipe cleaner for surfaces that need general cleaning.

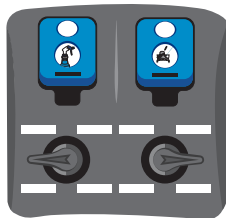

## M8 GLASS CLEANER Surface & Glass Cleaner

For use on mirrors, glass, porcelain, chrome, and counters.

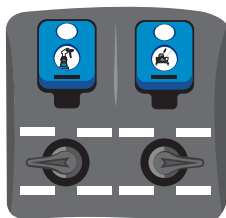

## M10 ODOUR CONTROL Malodour Counteractant

For use in cleaning solutions to eliminate chemical smells or to eliminate malodours. Use in a spray bottle as an air freshener.

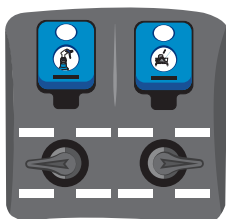

## M11 DEGREASER Hard Surface Cleaner & Degreaser

Spray and wipe cleaner and degreaser. For use on desks, tables, walls, counters, and any surface not harmed by water.

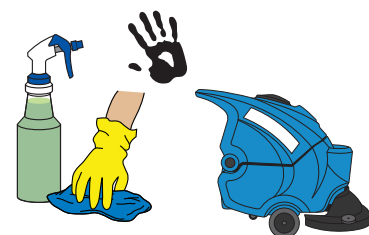
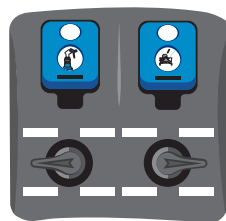

# Proportioning Systems

A dilution system automatically mixes a concentrated chemical with water to make a ready-to-use solution that is generally dispensed into a spray bottle or mop bucket. A dilution system offers 3 major advantages: cost savings, cleaner facility and employee safety.

Format	Code
Unit	H35331



**AccuMax**  
Proportioning System

Dilution is controlled by drawing chemical through metering tips of varying sizes and injecting this metered amount into the water flow.

Format	Code
Buddy Jug Complete	51055



**Buddy Jug**  
20 L Jug

Commercial-grade 20 L jug that is user-friendly for easy filling and pouring of diluted chemicals in spray bottles. Translucent to quickly see what's inside. Ideal for storing liquids on a shelf. Parts sold separately.

Format	Code
Foaming (Black)	51700
Lotion (White)	51701



**Open Top Dispenser**  
Soap Dispenser

Made of tough and durable plastic, these 800 mL dispensers are easy to operate, fill and clean. Ideal for dosing of liquid soaps, lotions and shampoos in washrooms, bathrooms, care and medical rooms, and more.

Format	Code
Unit	51773



**Dispensing Pump**  
Dispensing/Proportioning Pump

Attaches directly to bottle for on-the spot use and offers a highly controlled pumping action from its fixed nozzle, with reduces splashing and a highly directed liquid output. Dispenses 15 mL (0.5oz) per pump.

Format	Code
Grey – 1:256	51069
Green – 1:120	51093
Blue – 1:80	51092
Yellow – 1:40	51091
Black – 1:20	51072
White – 1:10	51070



**Eco Easy Fill**  
Portable Proportioning Unit

The water flows through the unit and venturi pressure pulls the correct amount of concentrate as determined by the built-in metering device and mixes it with water for easy dispensing.

Format	Code
3+1	HSP7983
2+2	HSP7984



**EnviroFlex**  
Proportioning System

This system can be configured with 2 (1 GPM)+2 (3.5 GPM) or 3 (1 GPM)+1 (3.5 GPM), allowing product and application flexibility and allowing you to customize the system to your needs.

Format	Code
Unit	HSP9184



**ModularFlex System**  
Proportioning System

Delivers the flexibility to dispense multiple products and to configure the system as it works best for your application.

Format	Code
Unit	51774



**Proportioning Pump**  
 Dispensing/Proportioning Pump

Attaches directly to bottle for on-the-spot use and includes a stopper mechanism that allows for either a 15 mL pump or a 30 mL pump.

Format	Code
Unit	51075
Tether Kit	51074



**RiteFlex**  
 Handheld Dispenser

Simply attach the hose to a water source and effortlessly fill mop buckets, sinks, auto-scrubbers, or empty bottles, all without the need to hold the weight of the container.

Format	Code
Unit	H5844



**Satellite Sprayer**  
 Portable Dispensing System

Offers a mobile dispensing system at low-cost. It is a portable means of accurately diluting concentrated cleaning products for use in mop buckets, sinks, auto scrubbers, tanks and other containers.

Format	Code
Unit	H5824



**Satellite Sprayer/Foamer**  
 Portable Dispensing System

This innovative device is designed for versatile applications, including foaming, spraying, and rinsing, providing a comprehensive solution for all your cleaning needs.

Format	Code
Lotion, 900 mL	51703
Foaming, 900 mL	51704



**Soap Dispenser**  
 Soap Dispenser

This surface mounted unit can affix to the wall at a convenient height that allows the users to easily access them. Available in three sizes: small, standard, large, to fit the space and usage level of all environment.

Format	Code
Foaming (Soap)	51680
Lotion (Soap)	51681
Spray (Hand Sanitizer)	51682



**Touchless Soap Dispenser**  
 Automatic Soap Dispenser

A touchless soap dispenser that allows for effective hand cleaning or sanitizing while avoiding germs or infection by eliminating physical contact with the unit.

Format	Code
Unit	H616



**Hydro Pump**  
 Push-Pump Chemical Dispenser

Unlike traditional methods, the HydroPump doesn't require a water hook-up. It ensures precise dosing of both viscous and non-viscous cleaning solutions, offering exceptional accuracy.

Format	Code
Unit	72001



**Hydro Master**  
 Drum Proportioner

State-of-the-art wall or drum-mounted system designed to provide efficient water distribution. With its Easily adjust flow rates and optimize water distribution for your products with unmatched accuracy.

Format	Code
Worldchem Dispenser	H959
Hose	H132
Multi-Function Nozle	H960



**WorldChem System**  
 Wall Mounted Foaming & Spraying Dispensing System

Automatically dilutes and dispenses concentrated cleaning products in a foaming and/or spraying mode while providing the end user with full volume rinse.

# Dispensing Accessories

A dilution system automatically mixes a concentrated chemical with water to make a ready-to-use solution that is generally dispensed into a spray bottle or mop bucket. A dilution system offers 3 major advantages: cost savings, cleaner facility and employee safety.



**Industrial Rack**  
[Wall Mounted Jug Rack](#)

This tough and durable wall mountable metal dispenser is designed for use in wet or dry environments. It fits 4 L, 4.5 L & 5 L bottles.

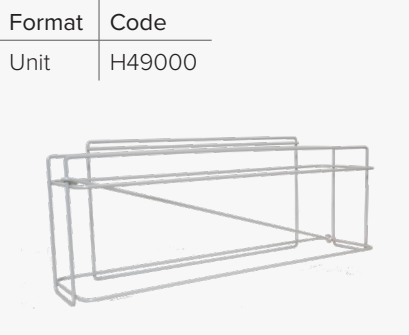

**Lockable Wire Rack**  
[Lockable Wire Rack](#)

This chemical holder will accommodate four 4 L or 5 L, or seven 2 L bottles. Made from sturdy steel wire and come with a locking bar. Powder coated with a tough grey finish that can be easily cleaned.



**Wall Bracket**  
[Wipe Dispenser](#)

Metal rack is affixed to the wall for easy wipe dispensing. Compatible with all Dustbane wipes.

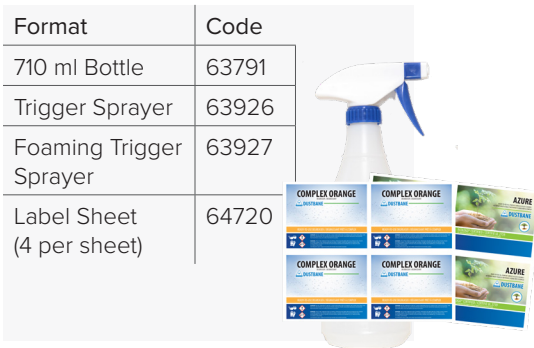

**Workplace Accessories**  
[Workplace Accessory](#)

## Cost In Use:

An important factor to consider when purchasing a product is the cost in use. Comparing the litre's prices is not a good indication of the final price paid. The formula to obtain the cost in use is as follows:

$$\text{Unit Price} / \text{Unit Size} = \text{Price Per Litre}$$

$$\text{Price Per Litre} / \text{Sum of Parts from Dilution} = \text{Cost in Use (Per Litre)}$$

Dilution	Price	Format
1:80	\$27.00	4 L

$$\$27.00 / 4 \text{ L} = \$6.75$$

$$\$6.75 / (1+80) = \mathbf{\$0.08 \text{ per litre}}$$





# Dilution Chart

Use this chart to determine the chemical to water ratio. The smaller number is the parts of chemical, while the large number is the parts of water.

DILUTION RATIO	TIP COLOUR		OZ / CAD GAL	ML / L	OZ / US GAL
	1 GPM	3.5 GPM			
1:1	NO TIP	NO TIP	160	1000	128
1:3	GREY	1:15	54	333	43
1:4	BEIGE	GREY	40	250	32
1:5	RED	BLACK	32	200	26
1:10	TAN	BEIGE	16	100	13
1:15	GREEN	-	11	67	9
1:20	ORANGE	WHITE	8	50	7
1:30	YELLOW	LIME	6	34	5
1:40	AQUA	GREEN	4	25	4
1:60	PURPLE	BROWN	2.7	17	2
1:64	PURPLE	ORANGE	2.5	16	2
1:80	LIGHT GREY	DARK BLUE	2	12.5	1.6
1:120	PRECISION PINK	YELLOW	1.35	8.5	1.2
1:128	PINK	AQUA	1.25	8	1
1:160	LIGHT PURPLE	PURPLE	1	6.25	0.8
1:256	RED PURPLE	LIGHT GREY	0.63	4	0.5
1:320	LIGHT ORANGE	PINK	0.5	3.25	0.4
1:500	OLIVE	-	0.32	2	0.3

\*Water thin products: 40 psi

## CONVERSION CHART:

1 US gal =	128 oz
1 qt. =	32 oz
1 pt. =	16 oz
1 cup =	8 oz
1 oz =	1/8 cup
2 cups =	1 pt.
2 pt. =	1 qt.
4 qt. =	1 gal

## EQUIVALENCE:

1 CAD gal = 4.55 L	1.25 US gal
1 US gal = 3.78 L	0.8 CAD gal
1 L = 0.22 CAD gal	0.26 US gal

## DISPENSING PUMP:

1 pump with clip =	15 mL
1 pump without clip =	30 mL
15 mL =	0.5 oz
30 mL =	1.0 oz

## Cost In Use:

An important factor to consider when purchasing a product is the cost in use. Comparing the litre's prices is not a good indication of the final price paid. The formula to obtain the cost in use is as follows:

$$\text{Unit Price} / \text{Unit Size} = \text{Price Per Litre}$$

$$\text{Price Per Litre} / \text{Sum of Parts from Dilution} = \text{Cost in Use (Per Litre)}$$

Disinfection			
Dilution	Price	Format	
1:20	\$2700	4L	

$$\text{\$2700} / 4\text{L} = \text{\$675}$$

$$\text{\$6.75} / (1+20) = \text{\$0.32 per litre}$$

Cleaning			
Dilution	Price	Format	
1:80	\$2700	4L	

$$\text{\$2700} / 4\text{L} = \text{\$675}$$

$$\text{\$6.75} / (1+80) = \text{\$0.08 per litre}$$

# Cleaning Tools

Cleaning sponges are a great tool for every day cleaning needs, and greatly aid in accomplishing a cleaning task. Selecting the right sponge for the job can make a real difference. Proper tools make a cleaning job a task instead of a chore.



**Light Duty Scouring Pads**  
[Scouring Pad](#)

Ideal for glass, stainless steel, porcelain, chrome, copper and ceramic surfaces. Won't scratch or dull most surfaces.



**Medium Duty Scouring Pads**  
[Scouring Pad](#)

Ideal for common cleaning jobs. Cleans pots, pans, kitchen equipment, floors, stairways and baseboards. Will not scratch or dull most surfaces.



**Extra Heavy Duty Scouring Pads**  
[Scouring Pad](#)

Ideal for pots and pans with its powerful scouring action. Removes heavily encrusted baked-on food. Great alternative to the metal scouring pads.



**Light Duty Scrubbing Sponge**  
[Scrubbing Sponge](#)

Dual-action cleaning tool. One side has a light-duty scouring pad for scrubbing and cleaning and the other, a cellulose sponge to quickly wipe up spills and messes. Will not scratch or dull most surfaces.



**Medium Duty Scrubbing Sponge**  
[Scrubbing Sponge](#)

Dual-action cleaning tool. One side has a medium-duty scouring pad for scrubbing and cleaning and the other, a cellulose sponge to quickly wipe up spills and messes.

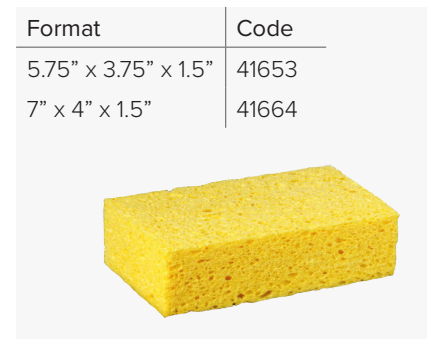

**Cellulose Sponge**  
[Sponge](#)

Ideal for general maintenance. More absorbent than polyurethane sponges and stronger so they last longer.

<b>#</b>			
3DShield.....	28		
<b>A</b>			
Acclamation.....	10		
Accolade.....	8		
AccuMax.....	38		
AirFlex.....	31		
Air Flex Holder.....	31		
Air Freshener.....	33		
Air Max.....	31		
Air Max Dispenser.....	31		
Aquascent.....	30		
Aquascent RTU.....	34		
Aqua Scrub.....	26		
Azure.....	4, 14, 32		
<b>B</b>			
Baseboard Stripper.....	33		
Bio-Bac II.....	4, 14, 19, 22, 26		
Bio-Bac Free.....	4, 14, 19, 22, 26		
Blu-Lite.....	26		
Blu-Lite Plus.....	26		
Buddy Jug.....	38		
<b>C</b>			
Challenger.....	9, 14		
Champion.....	7		
Champion RTU.....	7, 35		
Chewing Gum Remover.....	33		
Citrus Air.....	33		
Clearinse.....	18		
Compare.....	15		
Complex Orange.....	18		
Corsage.....	24		
Cross-Link.....	9		
<b>D</b>			
De-Foam.....	32		
Disappear.....	30		
Disinfect.....	16, 34		
Dish Shine.....	32		
Dispensing Pump.....	38		
Dispenser (Soap).....	39		
Doodle Buster.....	4, 33		
Dri-Foam.....	22		
Dustbane Sweeping Compound.....	32		
Dynamite.....	7		
<b>E</b>			
Eco Easy Fill.....	38		
Eco-Expert.....	4, 22		
Eliminate.....	35		
Elite.....	10		
Emerald.....	4, 19		
Endurance.....	10		
Enviro Block.....	28		
EnviroFlex.....	38		
Excelsior.....	5, 14		
Expo.....	32		
Extra Heavy Duty Scouring Pads.....	42		
<b>F</b>			
Film Away.....	5, 9, 15		
Formula-1.....	7		
Foundation.....	5, 8		
Friendly Air.....	30		
Fryer and Griddle.....	33		
<b>G</b>			
Gard.....	8		
Glacier.....	10		
Graffiti Remover.....	33		
Gran-Prix XL.....	10		
Green Kleen.....	15		
Green Kleen Industrial.....	18		
Green Kleen Industrial RTU.....	35		
<b>H</b>			
Hand & Body Shampoo.....	5, 24		
Hi-Genic.....	26		
Hygo H <sub>2</sub> O.....	32		
Hydro Pump.....	39		
Hydro Master.....	39		
<b>I</b>			
Industrial Rack.....	25, 40		
<b>L</b>			
Large Cellulose Sponges.....	42		
Light Duty Scouring Pads.....	42		
Light Duty Scrubbing Sponges.....	42		
Lockable Wire Rack.....	40		
<b>M</b>			
M1 Restroom Cleaner.....	36		
M6 Oxy-Q.....	36		
M7 Neutral Cleaner.....	36		
M8 Glass Cleaner.....	36		
M11 Degreaser.....	36		
Magic.....	32		
Magic (aerosol).....	33		
Medium Duty Scouring Pads.....	42		
Medium Duty Scrubbing Sponges.....	42		
ModularFlex Series.....	36		
ModularFlex System.....	36, 38		
<b>N</b>			
Neutralizer.....	9		
Nitro.....	27		
Nu-Life.....	15		
<b>O</b>			
Orang-A-Tang.....	18		
Organic.....	5, 26		
Orbit.....	10		
Oven Cleaner.....	33, 35		
Oxy D.S.T.....	5, 15, 22, 27		
Oxy-Q.....	5, 16, 22, 27		
Ourfresh 2.0.....	31		
<b>P</b>			
Pinosan.....	17		
Polar.....	5, 27		
Polypower.....	25		
PowerKleen.....	19		
Power Lift.....	18		
PowerWash.....	18		
Preference.....	14		
Presto.....	27		
Dispensing Pump.....	38		
Proportioning Pump.....	39		
<b>Q</b>			
QuatPlus.....	6, 16		
Quatromycide V.....	17		
Quatromycide VRTU.....	34		
Quick Fix.....	27		
<b>R</b>			
Resolve.....	18		
Restore.....	6, 9		
RiteFlex.....	39		
Runway.....	10		
<b>S</b>			
Sanitizing Wipes.....	35		
Satellite Sprayer /Foamer.....	39		
Stainless Steel Cleaner.....	33		
Stainless Steel Wipes.....	35		
Stink Relief.....	30		
StrateFlush.....	27		
Surface Kleen Plus.....	19		
Super-Sorb.....	32		
<b>T</b>			
Time-Out Plus.....	6, 7		
Touchless Soap Dispenser.....	39		
Tradition.....	6, 24		
Tradition Plus.....	6, 24		
Triple Action.....	17, 18		
Triple Action Multi.....	35		
<b>U</b>			
Ultra Orange.....	31		
UniTab.....	23		
<b>V</b>			
Vanguard.....	16		
Vanguard RTU.....	35		
Vanguard 256.....	17		
Vayselle.....	6, 32		
<b>W</b>			
Wipes Wall Bracket.....	40		
Workplace Accessories.....	40		
Workplace Labels.....	40		
WorldChem System.....	39		



## Vision

To be a growth company focused on continuously improving the customer experience through our people, products, and processes while making a positive impact on society and the environment.



### Customer Intimate

Meet customer expectations.



### Execute

Deliver results.



### Growth

Be a high growth company where staff also grow professionally.



### Respectful & Inclusive

Show all stakeholders respect.  
Communicate effectively and listen  
to learn from others.



### Meaning

Positively impact people and the planet.