

SQUARE SCRUB[®] Versatility²

EBG-Series Floor Preparation Machines



Made in the USA

As with most success stories, Square Scrub® was born from a simple idea on how to make a product more effective. When Kevin Brady began designing and building the first EBG machines in his basement, Kevin chose to name his design “EBG” because his father always told him he could accomplish anything he wanted with a little “elbow grease.”

Square Scrub® remains committed to the continuous improvement of its signature EBG floor machine through large and small changes. Additionally, a commitment to building products with high-quality materials that are Made In America has been a tenet of Square Scrub’s from the beginning, a concept that is dear to every one of our team members.

Through teamwork, dedication, and the strong drive to make every project a great success, all the team members of Square Scrub® have contributed to Square Scrub's great success. Our family here really cares about what we build.

2007

2007: Design and development of orbital floor machines begin.

2008: Square Scrub®, LLC and the EBG units are officially born!

2008

2010

2010: Begin building North American Independent Rep Network. Continuous improvements to the EBG Machines.

2012: Springing forth from our roots doing gym floors, Square Scrub® introduces the Bucket-on-a-Stick® for quickly and easily applying any floor finish. Customers rave about how easy it is to use and clean up! They also appreciate the fact it is non-proprietary.

2012

2013

2013: Due to all the time Square Scrub® has saved customers we trademarked the term “Versatility®”.

2015: Introduced the Doodle Scrub®, a 4” x 9” inch version of the larger EBG machine. Finally, small, tight spaces can be cleaned mechanically, forever saving the backs and arms of cleaning technicians!

2015



Testing an early EBG machine in a tub of stripper as we worked on continually improving the unit



An early prototype of the Doodle Scrub® at an ISSA show



Square Scrub® products have always been so easy to operate that even a child can do it! Training the next generation of cleaning technicians!

When running any equipment always wear proper PPE, including proper footwear"



Square Scrub® machines waiting to go to one of the largest school districts in North America



One of the first "Rep Meetings" as our team began to grow



329 pounds on a Pivot at ISSA show in 2012



2017: The Square Scrub® Pivot is introduced at ISSA and starts shipping the same day! The Pivot is immediately seen as a game-changer since the head of the unit is flat and balanced on the floor. This, along with a completely redesigned isolator system, greatly enhances the user's experience with the machine!

2018: Square Scrub® introduces the Doodle Mop®. Designed to help maintain floors when used in conjunction with a microfiber pad, this unit is in a category of its own!

2017

2017

2018

2019

2017: Square Scrub® moves into a custom-built facility designed to increase efficiency and create room for growth.

2017

2017: Square Scrub® introduces a patent-pending bearing design that virtually eliminates the possibility of water attacking the bearings on the unit. As a testament to the design and our confidence in it we increased the warranty to 5 years on the bearing. Although, we doubt you will ever need to actually use it!

2019: Square Scrub® introduces a battery system to power the Doodle Mop® and Doodle Scrub® units. The innovative design of the battery, placing it in the handle, also ETL listed and UN 38.3 approved, making it safe to ship anywhere in the world!

At the heart of our drive for innovation is a desire to help cleaning technicians achieve the best results maintaining the places we live, work, heal, and study while saving time and money. This is evident in products like the Bucket-on-a-Stick®, which helps apply any floor finish quickly, the Doodle Scrub®, which allows for true mechanical deep cleaning in areas that previously required manual cleaning, and the Doodle Mop®, which helps maintain floors and can help prevent cross-contamination in critical areas.

Though we may only have a handful of products, they are designed for maximum versatility, which is why our catalog is so large! There are so many things you can accomplish with Square Scrub® equipment that we just need that many pages to tell you about them! With Square Scrub® products there just is not a floor you can't clean, maintain, or restore! As we say at Square Scrub®, "Versatility²®" means you only have to store, train, and maintain one piece of equipment for your floor care needs!

Proud to be American Made

Square Scrub® machines are built in Jonesboro, AR.

Our machines are truly American Made. The steel used in our frame comes from Arkansas. The Leeson motor is made in Black River Falls, WI. We believe in American made products, and the opportunities created by supporting American companies. That is why we make every effort to incorporate components that are made right here in the United States of America.



Quality Control

We have a saying at Square Scrub®, "Perfect is good enough!" Every machine we build is quality tested and inspected. We care about the reputation of American made products, so we strive to build a sturdy, hard-working, solid machine that is **BUILT TO LAST!**

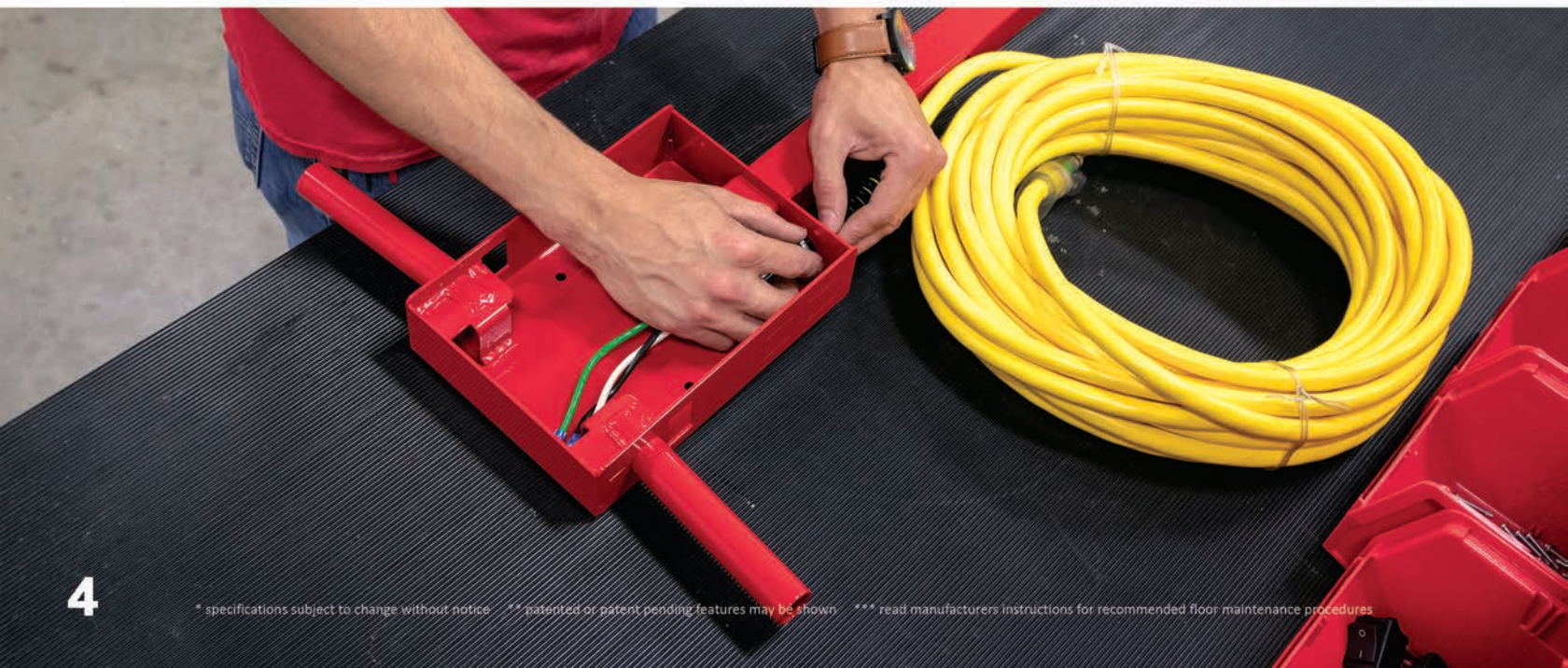

Fast Delivery

Time is Money.

At Square Scrub®, we know that your time is valuable. Our machines are designed to save you time, affording more money making opportunities. We know that you don't have time to wait weeks for your machine. That is why we strive to fulfill every machine order within one day of receiving an order. For pads and accessories, we do our best to get them out to you the next day, so you can get to work ASAP!



800-557-6822 | [squarescrub.com](https://www.squarescrub.com)

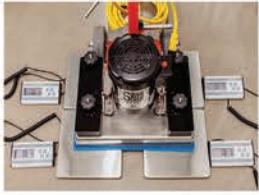

1 The Square Scrub[®] Pivot base sits flat on the floor and distributes pressure evenly across the entire contact area resulting in superior performance.



2 Cleans into corners where round machines leave work that needs to be done by hand.

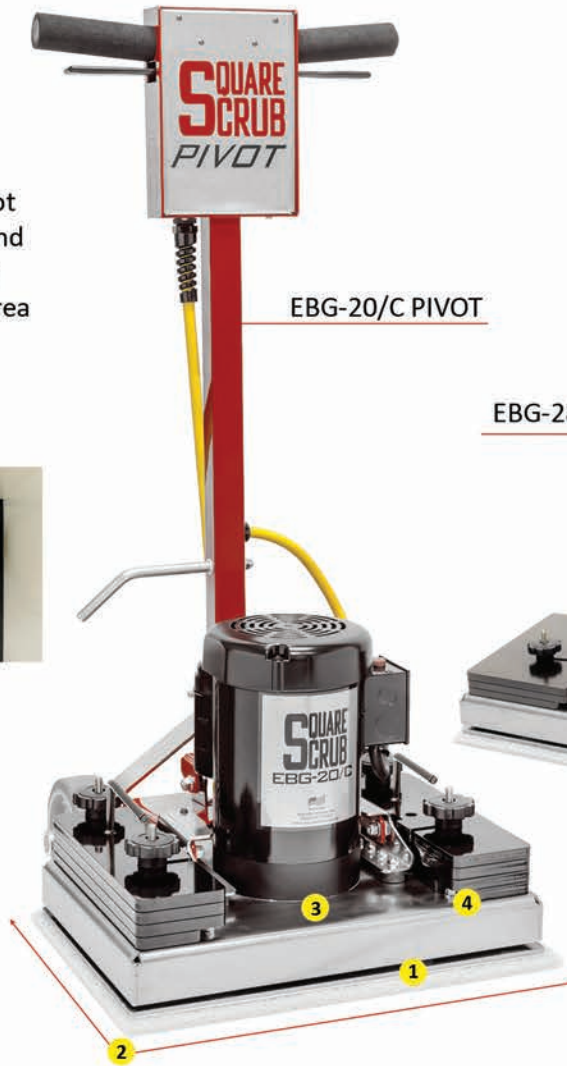

EBG-20/C PIVOT

EBG-28 PIVOT

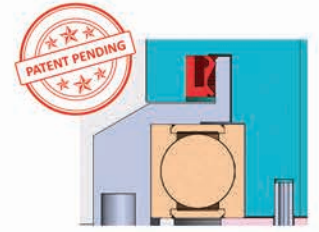

3 Our patent-pending dual-seal design protects the bearing. The 5-year warranty on the bearing protects your peace of mind.

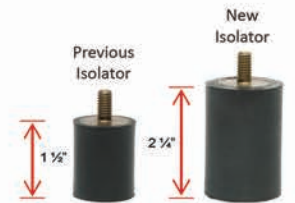

4 Longer, and thicker isolators greatly reduce vibration and increase user comfort.



Learn more about the Pivot!

Versatility² means a single Square Scrub[®] Pivot you can clean, maintain, or restore any floor in your facility!



Cleans Carpet



Microfiber Carpet Cleaning Pad



Dry Strip/Prep VCT



SQP Pad

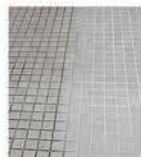

Cleans Tile & Grout



Blue 3D Scrub Pad



Wet Strip VCT



SHO Pad



Cleans LVT



Blue 3D Scrub Pad



Sands Wood Floors



Sandpaper



Screen Gym Floors



Sandscreen



Stone Polishing



3M TRIZACT[™] TZ Diamond Abrasive Strips



Made in the USA



EBG-20/C PIVOT



EBG-28 PIVOT

Specifications

	EBG-20/C PIVOT	EBG-28 PIVOT
UL/CSA/CE Certified	Yes	Yes
Base Weight w/o Weights	106 lbs	117 lbs
Total Assembled Weight	156 lbs	197 lbs
Maximum Weight Capacity	232 lbs	197 lbs
Stainless Steel Frame	10 gauge	10 gauge
Stainless Steel Base	7 gauge	7 gauge
3/4 " Solid Steel Axle	Yes	Yes
Adjustable Handle	Yes	Yes
6"x2" Non-Marking Wheels	Yes	Yes
Motor	3450 1.5 hp	3450 1.5 hp
Operating Sound Output	69 db	69 db
Power Cord	50 ft/14 gauge	50 ft/14 gauge
Lighted Plug	Yes	Yes
Amp Draw	6.9 amps	8.2 amps
Pad Size	14x20	14x28
Number of Isolators	4	8
Max Oscillations	3450/minute	3450/minute
Removable Weights	Yes	Yes
Vibration Reducing Handle	Yes	Yes
Noise Reducing Weight Spacers	Yes	Yes
Stone Care Capable	Yes	Yes
Carpet & Rug Institute Certified	Yes	N/A
Dust Containment Kit	Yes	Yes
Built-in Hour Meter	Optional	Yes
Two-Piece Handle	Optional	Optional



Clean Tile and Grout



Cleaning LVT (Luxury Vinyl Tile)



Cleaning Stone, Concrete & Terrazzo



Wood Flooring Sanding & Prep



Dry Floor Prep (VCT)



Dry Prep Gym Floors



EBG-20/CV PIVOT



EBG-28V PIVOT



HEPA Dry Vac Kit (SS EBG-HDVK)



Solution Tank (SS EBG-WTS20) (SS EBG-WTS28)

* specifications subject to change without notice ** patented or patent pending features may be shown *** read manufacturers instructions for recommended floor maintenance procedures



SS EBG-20/C PIVOT

with 2 piece handle - **EBG-20C PVT 2PC**

The EBG-20/C PIVOT Surface Preparation Machine features a 20" base, 3450 rpm motor, 50-foot, 14 gauge power cord with lighted hospital grade plug, removable weights and Dust Containment Kit. The Pivot includes a pivoting head that follows uneven floors more efficiently.



SS EBG-20/CV PIVOT

with 2 piece handle -

EBG-20CV PVT 2PC

A standard EBG-20/C PIVOT Floor Preparation Machine with the HEPA Dry Vac installed.



SS EBG-28 PIVOT

with 2 piece handle - **EBG-28 PVT 2PC**

The EBG-20/C PIVOT Surface Preparation Machine features a 28" base, 3450 rpm motor, 50-foot, 14 gauge power cord with lighted hospital grade plug, removable weights and Dust Containment Kit. The Pivot includes a pivoting head that follows uneven floors more efficiently.



SS EBG-28V PIVOT

with 2 piece handle -

EBG-28V PVT 2PC

A standard EBG-28 PIVOT Floor Preparation Machine with the HEPA Dry Vac installed.



Square Scrub[®] Solution Tank

SS EBG-WTS20 for SS EBG-20/C PIVOT

SS EBG-WTS28 for SS EBG-28 PIVOT

For use when stone care and other applications where water is needed. The Solution Tank is easy to install, the front mounted dispersion bar slides under the weights for a secure fit. The tanks holds 1.25 Gallons of water.



HEPA Dry Vac Kit

SS EBG-HDVK for SS EBG-20/C PIVOT & SS EBG-28 PIVOT

The HEPA Dry Vac Kit mounts directly to the machine. It has a 6 quart capacity and pulls under 4.5 amps. With the Dust Containment Kit, the Dry Vac Kit significantly reduces airborne particles.



20" & 28" Dust Skirt

SS 142005 for SS EBG-20/C PIVOT

SS 142805 for SS EBG-28 PIVOT

Our Dust Skirt kit adds a measure of particle control, and installs in minutes. Includes: adhesive strip and velcro.



HEPA Dry Vac Ultimate Micro Lined Bag -

SS EBG-HDVK-UHB for HEPA Dry Vac Kit

Replacement bags for use with the HEPA Dry Vac Kit.



HEPA DRY VAC Cloth Bag

SS EBG-HDVK-CB

for HEPA Dry Vac Kit

Six quart cloth replacement bags for use with the HEPA Dry Vac Kit.



Complete Motor Saver with

HEPA Filter - SS EBG-HDVK-CMS

for HEPA Dry Vac Kit

Replacement HEPA filter for use with the HEPA Dry Vac Kit.



LVT - Textured LVT gets filled with biofilm over time. The Blue 3D Scrub pad easily digs out the dirt and biofilm. Just add water to the floor's surface.

3D Blue Scrub Pad



20" PIVOT - SS P1420TGB
28" PIVOT - SS P1428TGB



VCT - When VCT floors need to be refinished, an SQP pad is used for dry stripping and an SHO pad is used for wet stripping. Use a 1/4" White Driver Pad when using these pads.

SQP Pad



20" PIVOT - SS P1420SQP
28" PIVOT - SS P1428SQP

SHO Pad



20" PIVOT - SS P1420SHO
28" PIVOT - SS P1428SHO

1/4" White Driver Pad



20" PIVOT - SS P1420DRIVER
28" PIVOT - SS P1428DRIVER



Tile & Grout - The grout lines on tile & grout floors collect biofilm. Use the Blue 3D Scrub pad to remove the biofilm. Just add water to the floor's surface.

3D Blue Scrub Pad



20" PIVOT - SS P1420TGB
28" PIVOT - SS P1428TGB



Carpet - Combined with our Carpet Encapsulation Cleaner, the Microfiber Carpet Pad deep cleans high traffic carpeting.

Microfiber Carpet Pad



20" PIVOT - SS P1420CB
28" PIVOT - SS P1428CB

Encapsulating Carpet Cleaner



SS EBG-ECC



Rubber Flooring - The Xtreme Sponge cleans rubber flooring. Just saturate the pad in water, make overlapping passes, and make certain the pad stays wet.

Xtreme Sponge



20" PIVOT - SS P1420XTR
28" PIVOT - SS P1428XTR



Wood Floors - Our sandpaper comes in a variety of grits for smoothing wood surfaces. Use dry on wood flooring or decks.

Pro Sandpaper



20" PIVOT - Grits 24 to 100
28" PIVOT - Grits 24 to 100

Standard Sandpaper



20" PIVOT - Grits 20 to 100
28" PIVOT - Grits 20 to 100

1/4" White Driver Pad



20" PIVOT - SS P1420DRIVER
28" PIVOT - SS P1428DRIVER



Gym Floors - Sandscreens are good for prepping wood surfaces for recoating, such as gym floors. If the finish is water based, a SQP pad can be used with a 1/4" White Driver as well.

Sandscreen



20" PIVOT - Grits 60 to 150
28" PIVOT - Grits 60 to 180

Red Driver Pad



20" PIVOT - SS P1420RED
28" PIVOT - SS P1428RED



Terrazzo - TRIZACT™ TZ Diamond Abrasive Strips create a smooth, highly-refined surface. Great for concrete, marble, terrazzo, & more. Use with the 1/4" White Driver Pad.

3M TRIZACT™ Diamond TZ Gold



Coarse - TZD GOLD

3M TRIZACT™ Diamond TZ Red



Medium - TZD RED

3M TRIZACT™ Diamond TZ Blue



Fine - TZD BLUE

Purple Diamond Pad



20" PIVOT - SS P1420PD
28" PIVOT - SS P1428PD

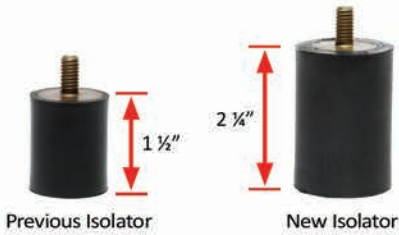
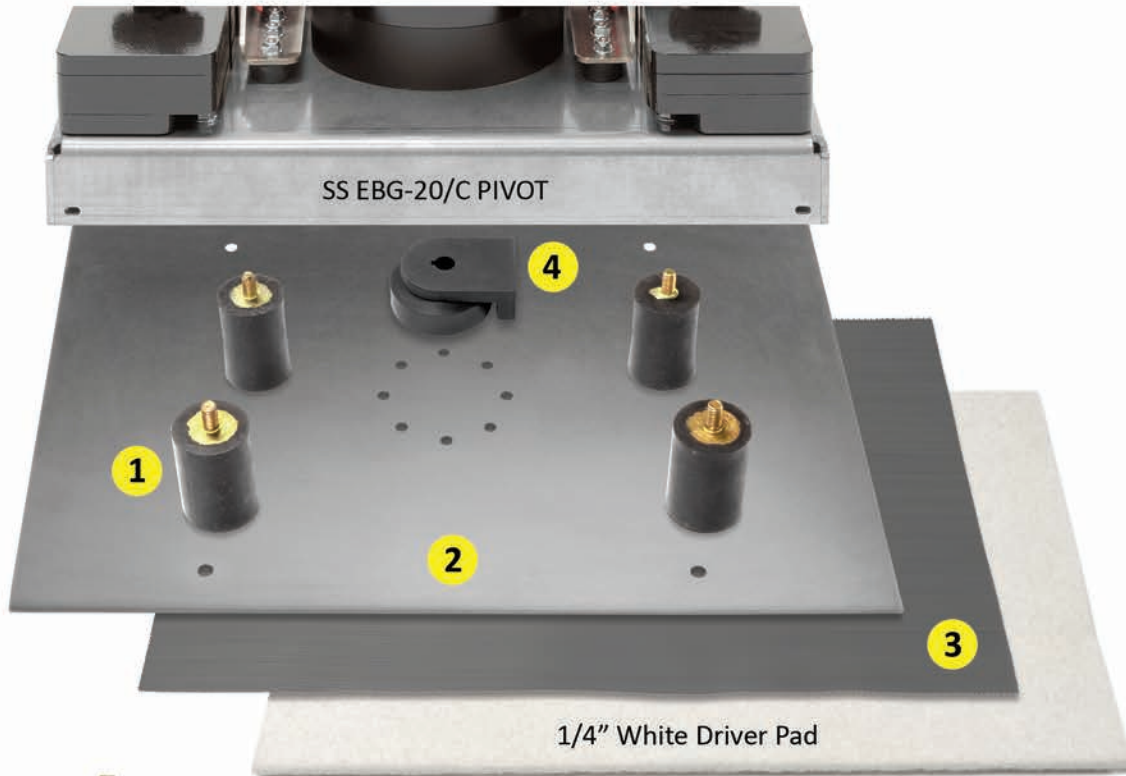

1 Isolators - In our quest for the best experience for our customers, we learned that lengthening and thickening the isolators reduced vibration and helped the machine operate more smoothly.

2 Base Plate - Our base plate is made from stainless steel with high nickel content to avoid corrosion. Unlike our competitors who screw isolators into their base, we screw through the base plate into the isolators with stainless steel screws to make maintenance on the Pivot easy.

3 Grip face - We have never settled for "good enough" on our grip face and we believe our current version is the best grip face available! Our grip face is a single piece that covers the entire base plate of the machine. What this means for you is performance from every square inch of the Pivot and resistance to peeling from moisture!

4 Bearing Assembly - The bearing and eccentric assembly is the heart of any orbital cleaning machine. Although we are pretty sure you are never going to have to use it, our patent-pending dual-seal design is so effective at keeping moisture from the bearings that we gave it the longest warranty of any component on the Pivot, 5 years!





Made in the USA

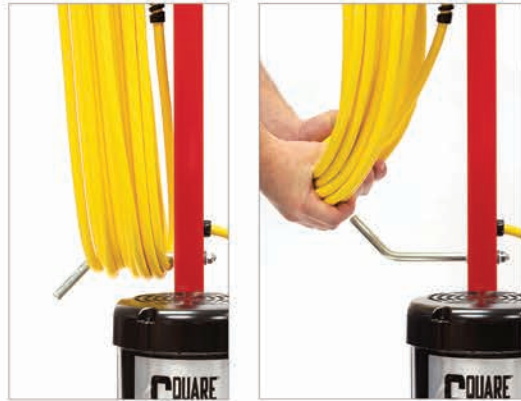

1. Quick Release Cord Wrap - Who wants to spend time unwrapping cords? With just a quick twist the cord can be removed and you can get to work.



3. More Isolators! - We added 10 low-profile isolators between the deck and the handle to reduce vibration felt by the operator.

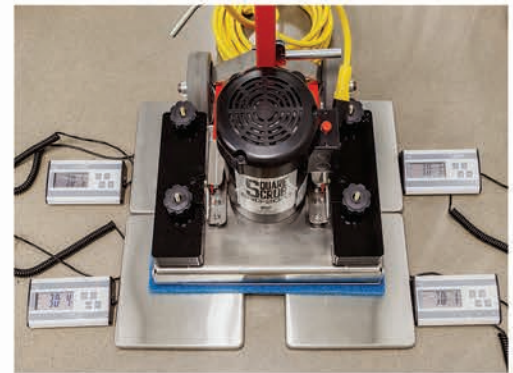

2. Perfect Balance - The Pivot is the only orbital machine that remains perfectly balanced regardless of the position of the handle. Competitive units lean to the back during operation causing pads to wear out, reducing the working surface in contact with the floor, and sending more vibration to the user. Perfect balance means less vibration and the best performance!



4. Dust Skirt - Unlike our competitors, the Pivot comes standard with a dust skirt for dry applications and solution control.



5. High-Quality Materials - Square Scrub® products are built for years of work, not the landfill! One example of this is the base of the Pivot which is made from 7-gauge stainless steel with a high nickel content to resist corrosion.

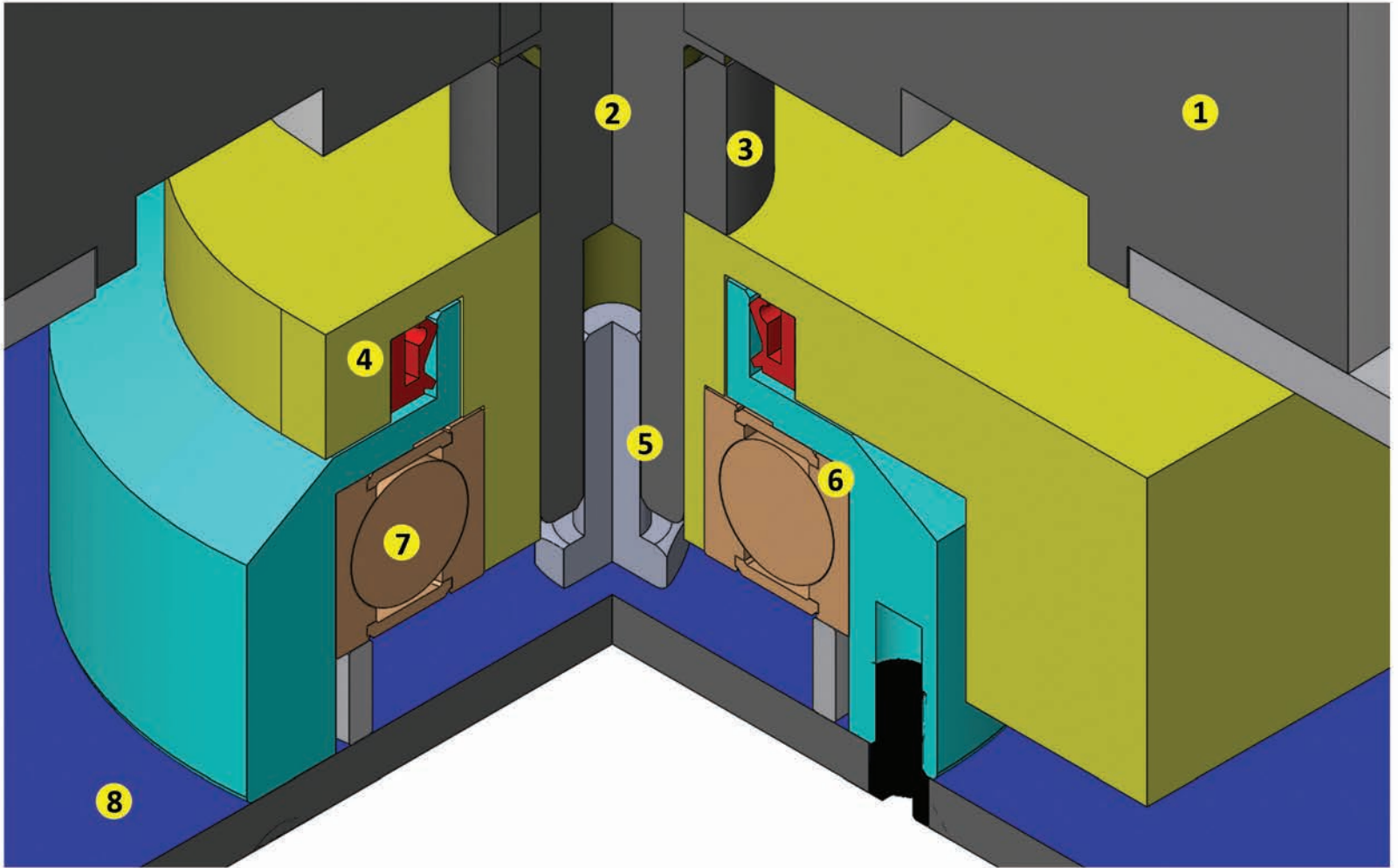

- 1 **Machine Base** - stainless steel frame that the motor and weights sit on.
- 2 **Motor Shaft** - connects to the eccentric assembly and driver plate.
- 3 **Motor Shaft Spacer** - spacer that is used between the eccentric assembly and the machine's base.
- 4 **Additional Seal** - additional protection against bearing failure caused by harmful contaminants.
- 5 **Motor Shaft Bolt** - used to connect the the eccentric assembly to the motor shaft.
- 6 **Bearing Seal** - protects the bearing from harmful contaminants.
- 7 **Bearing** - reduces friction inside the eccentric assembly.
- 8 **Aluminum Drive Plate** - The grip face attaches to the driver plate, which holds the pad into place. The drive plate is connected to the eccentric assembly.



Made in the USA

Eccentric Assembly Cutaway

The dual-seal design is so effective it is covered by a **5 YEAR WARRANTY!** (see owner's manual for details)

No other company in the market offers this kind of warranty, but you'll probably never need to use it!

Square Scrub is confident you will see many years of use from your EBG-20/C or EBG-28 Pivot floor machine!



Square Scrub Pivot Warranty



Square Scrub Pivot Owner's Manual



Protecting The Heart Of A Square Scrub Pivot

The top seal adds two additional layers of protection to help prevent bearing failure caused by harmful contaminants. This dramatically increases the life of the eccentric assembly.

Why is the additional seal important?

Without the additional seal, debris has a higher chance getting in and causing damage to the bearings.

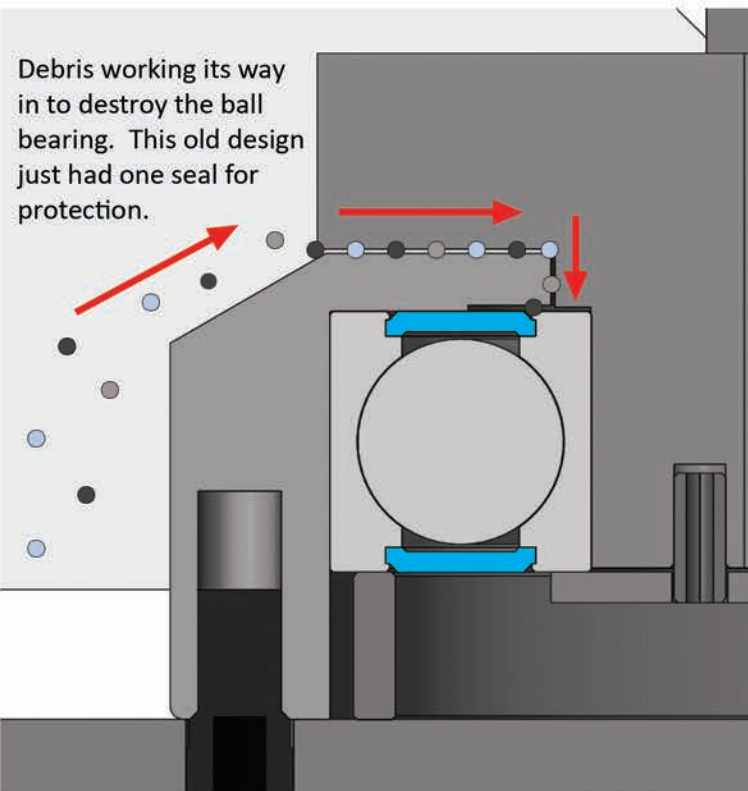

Debris working its way in to destroy the ball bearing. This old design just had one seal for protection.

Having an additional seal makes it nearly impossible for harmful contaminants to reach the bearing.

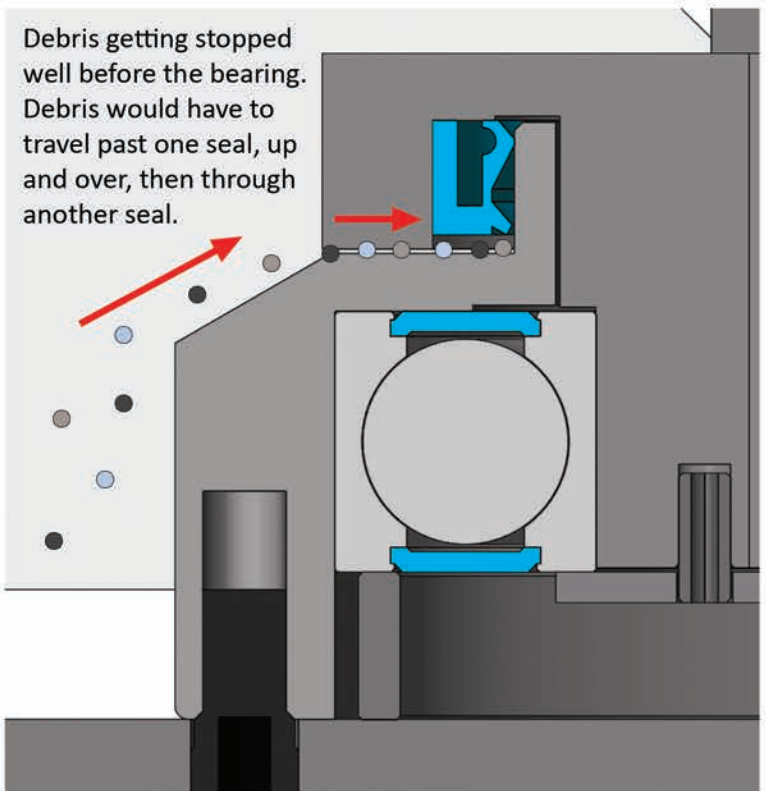

Debris getting stopped well before the bearing. Debris would have to travel past one seal, up and over, then through another seal.

1 The weight of the Doodle Scrub® gives it virtually the same downforce per square inch as the Pivot, while the compact 4" x 9" size of the Doodle Scrub® takes orbital cleaning power into areas conventional equipment cannot go! Restroom stalls, toilets, and small single-person bathrooms are all great places to use the Doodle Scrub®!

Doodle Scrub® / SS EBG-9



How to Use a Doodle Scrub®



Battery - The battery operates continuously for approximately 45 minutes.

BattScrub / SS EBG-9-BAT

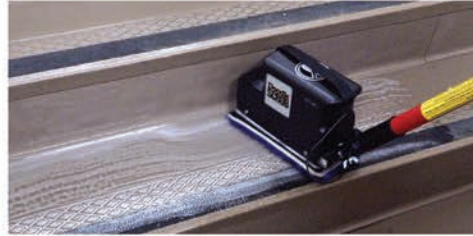

2 Battery Handle - The battery-powered handle eliminates the trip and fall hazards associated with cords and allows the cleaning technician to focus on the job, not managing the cord. In areas where there are no outlets, such as stairwells where fire code prohibits them, battery power allows workers to still get the job done!



Battery-Powered Doodle Scrub



3 Battery Meter - The convenient battery meter is located on the side of the Battery Doodle Scrub®. (opposite side of what's shown)

Versatility² means a single Doodle Scrub® can clean, maintain, or restore almost any floor in your facility!



Dry Strip/Prep VCT



SQP Pad

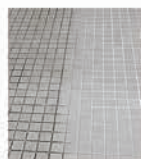

Cleans Tile & Grout



Blue 3D Scrub Pad



Wet Strip VCT



SHO Pad



Cleans LVT



Blue 3D Scrub Pad

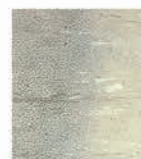

Resilient Flooring



Xtreme Sponge Pad



Stone Polishing



3M TRIZACT™ TZ Diamond Abrasive Strips



Made in the USA

Specifications

	Corded	Battery Powered
UL/CSA/CE Certified	Yes	Yes
Total Assembled Weight	21 lbs	20 lbs
Maximum Weight Capacity	21 lbs	20 lbs
Zinc Plated Steel Frame	10 gauge	10 gauge
Handle Attachment Points	2	2
Motor	4100 rpm .33 hp	4100 rpm .33 hp
Operating Sound Output	59 db	59 db
Battery Run Time	N/A	45 Mins (approx.)
Battery Charge Time	N/A	2 Hours (approx.)
Power Cord	30 ft/18 gauge	N/A
Lighted Plug	No	N/A
Amp Draw	1.5 amps	N/A
Pad Size	5.25x10.5	5.25x10.5
Number of Isolators	4	4
Max Oscillations	4100/minute	4100/minute
Stone Care Capable	Yes	Yes
Dust Containment Kit	Optional	Optional



**Doodle Scrub®
SS EBG-9**



**BattScrub
SS EBG-9-BAT**



**Doodle Skate®
SS EBG-9-SKATE**

* specifications subject to change without notice ** patented or patent pending features may be shown *** read manufacturers instructions for recommended floor maintenance procedures



LVT - Textured LVT gets filled with biofilm over time. The Blue 3D Scrub pad easily digs out the dirt and biofilm. Just add water to the floor's surface.

3D Blue Scrub Pad



Doodle Scrub[®]
SS P0511TGBV

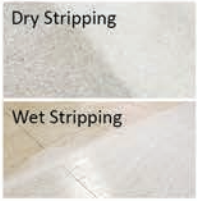

VCT - When VCT floors need to be refinished, an SQP pad is used for dry stripping and an SHO pad is used for wet stripping. Use a 1/4" White Driver Pad when using these pads.

SQP Pad



Doodle Scrub[®]
SS P0511SQP

SHO Pad



Doodle Scrub[®]
SS P1420SHO

1/4" White Driver Pad



Doodle Scrub[®]
SS P1420DRIVER



Tile & Grout - The grout lines on tile & grout floors collect biofilm. Use the Blue 3D Scrub pad to remove the biofilm. Just add water to the floor's surface.

3D Blue Scrub Pad



Doodle Scrub[®]
SS P0511TGBV



Resilient Sheet Flooring - The Xtreme Sponge cleans resilient sheet flooring. Just saturate the pad in water, make overlapping passes, and make certain the pad stays wet.

Xtreme Sponge

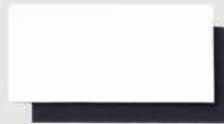

Doodle Scrub[®]
SS P0516XTR



Terrazzo - TRIZACT[™] TZ Diamond Abrasive Strips create a smooth, highly-refined surface. Great for concrete, marble, terrazzo, & more. Use with the 1/4" White Driver Pad.

3M TRIZACT[™]
Diamond TZ Gold



Coarse - TZDGOLD

3M TRIZACT[™]
Diamond TZ Red



Medium - TZDRED

3M TRIZACT[™]
Diamond TZ Blue



Fine - TZDBLUE

Purple Diamond Pad



Doodle Scrub[®]
SS P0511PD

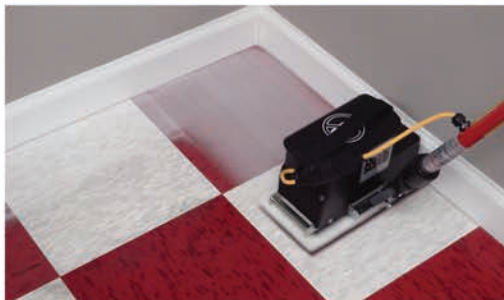

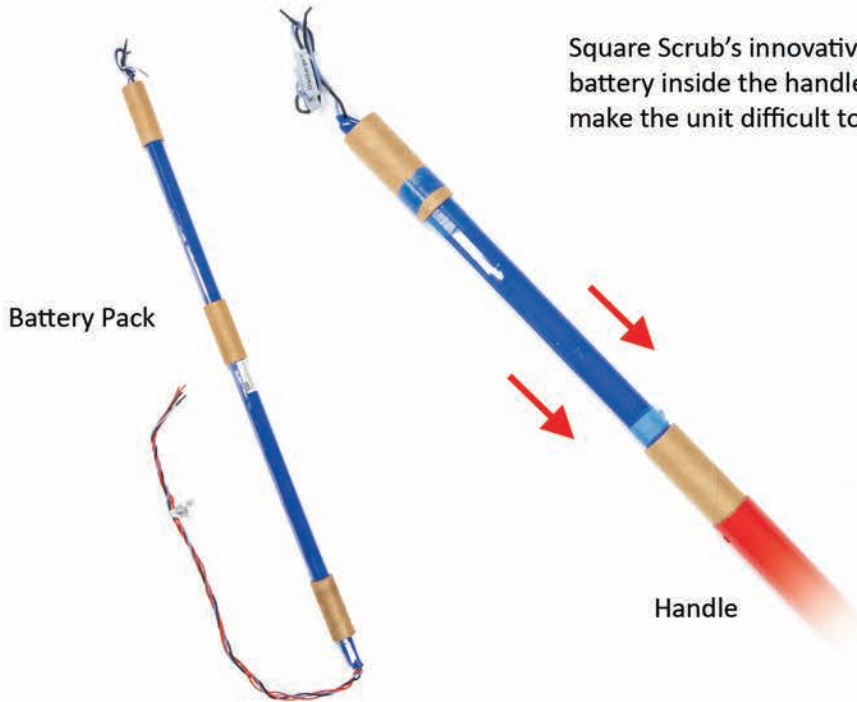

Square Scrub's innovative, space-saving battery design places the battery inside the handle where it does not add weight to the unit or make the unit difficult to operate.



The battery system carries ETL listed as well as UN DOT 38.3 approval for shipping anywhere in the world!

The battery pack contains a "battery management system" that monitors each individual cell for both temperature and voltage. This provides peace of mind when our battery pack is in your facility.

Battery Quick Facts:

- 42-volt system
- 2 hour charge time
- Doodle Scrub® run time: approximately 45 minutes continuous
- Doodle Mop® run time: approximately 1 hour continuous

Doodle Scrub® / Doodle Mop® Battery Handle - SS 051140



Battery handles are interchangeable between the Battery-Powered Doodle Mop® and Doodle Scrub®.

Battery Charger
SS 051145



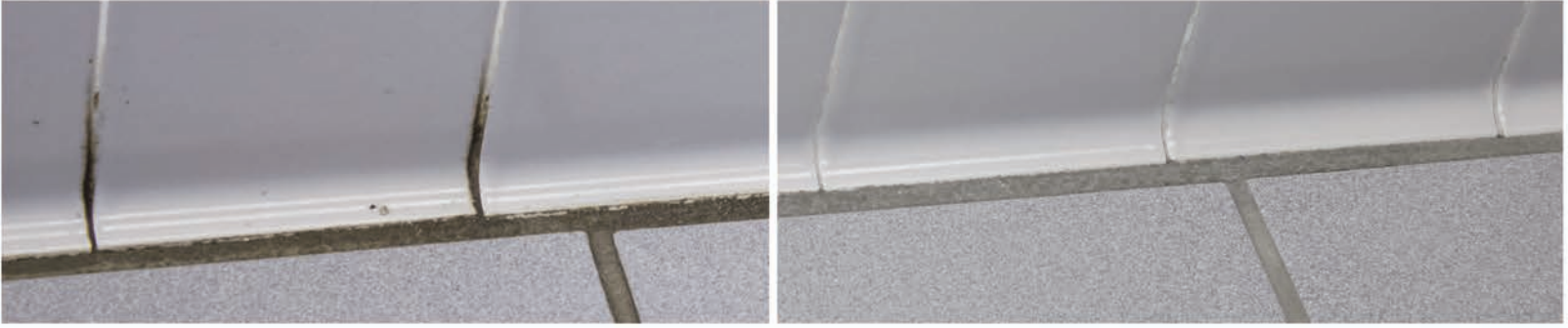

Durable nylon carry strap for easy transport.

Smooth pivoting action adjusts to wall contours.

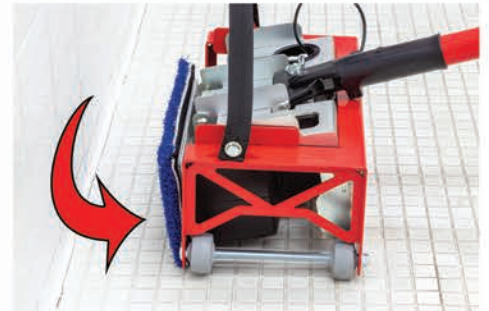
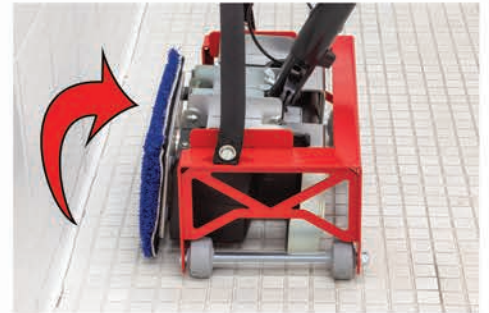

Doodle Skate®
Baseboard Cleaning



3D Scrub Pad
SS P0511TGBV



1. Remove the wingnut and plate, then slide the Doodle Skate® over the top of the Doodle Scrub®.

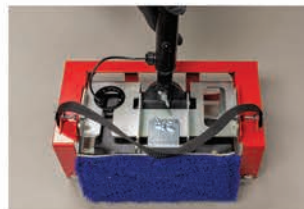

3. Connect the handle and tighten the wingnut.



2. Replace the plate and tighten the wingnut.



4. Connect the power cord leading from the handle to the base of the Doodle Scrub®.



The Doodle Skate® makes full pad contact with the baseboard for optimal cleaning.

The Doodle Scrub® provides 4100 rpms of baseboard scrubbing action.

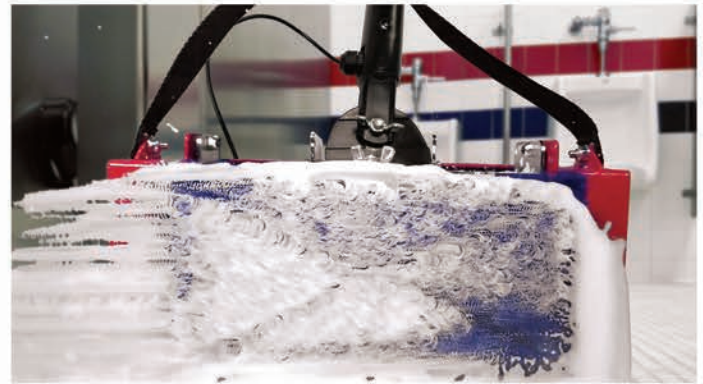

Doodle Skate® turns the scrubbing action parallel to the baseboard.

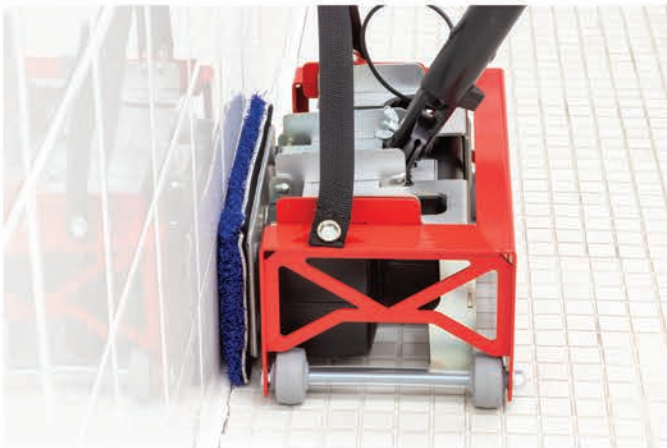

Square Scrub® vs The Competition

Watch the video above comparing the Doodle Skate® to the competition, and see the difference!



Upright machine baseboard attachments simply hit against the baseboard.



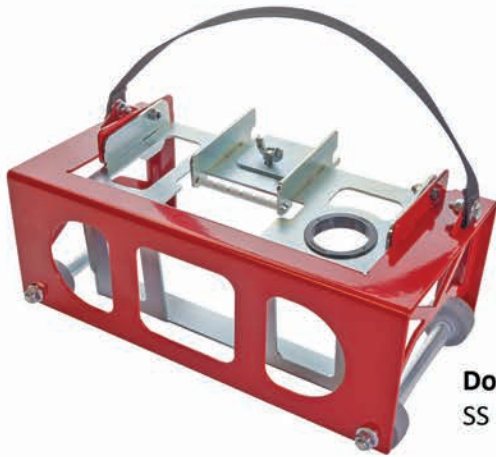

Doodle Skate®
SS EBG-9-SKATE



The **Doodle Scrub® Deluxe** comes with everything you need to get started cleaning baseboards and tight spaces in restrooms, kitchens, and more!

The Deluxe package comes with the following pads:

- 5 - Blue Driver Pads (4 additional)
- 4 - White Driver Pads
- 2 - SHO Pads
- 4 - SQP Pads
- 1 - White Pad
- 2 - 3D Scrub Pads
- 1 - Xtreme Sponge Pad

Doodle Scrub® Deluxe Configurations



Doodle Scrub® Deluxe
SS EBG-9-DLX



Battery Doodle Scrub® Deluxe
SS EBG-9-DLX-BAT



**Battery Doodle Scrub® Deluxe
with Extra Battery Handle**
SS EBG-9-DLX-BAT



Doodle Scrub®
SS EBG-9



Doodle Scrub® Deluxe
SS EBG-9-DLX



Battery Doodle Scrub® (BattScrub)
SS EBG-9-BAT

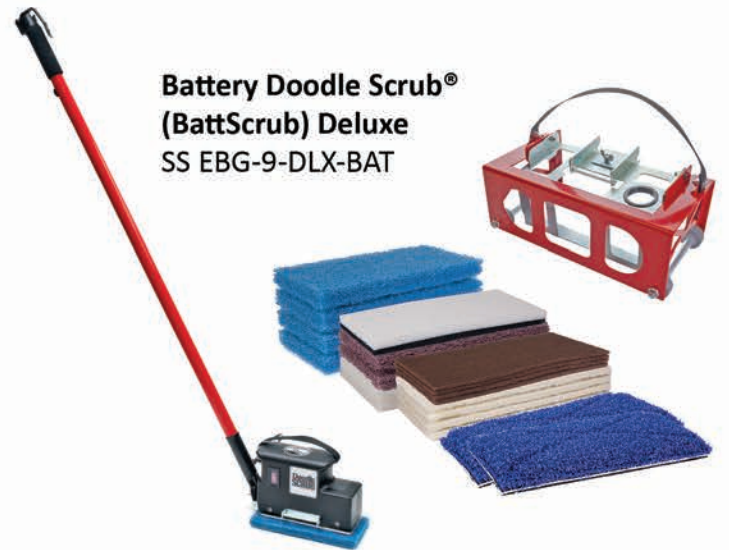

Battery Doodle Scrub® (BattScrub) Deluxe
SS EBG-9-DLX-BAT



Battery Doodle Scrub® (BattScrub) with Extra Battery Handle
SS EBG-9-BAT2



Battery Doodle Scrub® (BattScrub) Deluxe with Extra Battery Handle
SS EBG-9-DLX-BAT2

Used regularly, the Doodle Mop® and a microfiber pad maintain the appearance of LVT, Tile & Grout, Resilient, and VCT flooring. This extends the time between deep, restorative cleans, saving you time and money!

Doodle Mop® / SS EBG-16



Cleaning
LVT Flooring

Battery - The battery operates continuously for approximately 1 hour.

BattMop / SS EBG-16-BAT



1 Battery Meter The convenient battery meter is located on the side of the BattMop. (opposite side of what's shown)



There are three pads that can be used with the Doodle Mop® →



Contec Disposable Microfiber Pads
SS P0516DMF



Xtreme Sponge - SS P0516XTR



18" Microfiber Mop Head
SS 0403Z

Versatility² means a single Doodle Mop can help maintain almost any floor in your facility!





Made in the USA



Doodle Mop®
SS EBG-16

Specifications

	Corded	Battery Powered
UL/CSA/CE Certified	Yes	Yes
Total Assembled Weight	12 lbs	12 lbs
Maximum Weight Capacity	12 lbs	12 lbs
Stainless Steel Frame	10 gauge	10 gauge
Handle Attachment Points	2	2
Motor	4100 rpm .33 hp	4100 rpm .33 hp
Operating Sound Output	50 db	50 db
Battery Run Time	N/A	1 Hour (approx.)
Battery Charge Time	N/A	2 Hours (approx.)
Power Cord	30 ft/18 gauge	N/A
Lighted Plug	No	N/A
Amp Draw	1.4 amps	N/A
Pad Size	5.25x16	5.25x16
Number of Isolators	4	4
Max Oscillations	4100/minute	4100/minute



Xtreme Sponge
SS P0516XTR

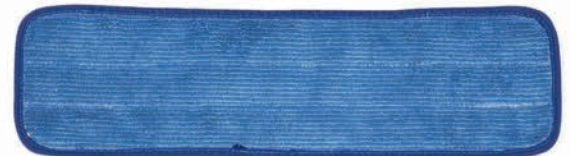

18" Microfiber Mop Head
SS 0403Z

BattMop
SS EBG-16-BAT



Disposable Microfiber Pads
SS P0516DMF

* specifications subject to change without notice ** patented or patent pending features may be shown *** read manufacturers instructions for recommended floor maintenance procedures

Case Study #1: Doodle Scrub and Contec Single-Use Microfiber in Discharge Cleaning

During the COVID-19 pandemic, the cleanliness of the spaces we occupy has become a front-of-mind consideration. As occupancy rates in hospitals and emergency rooms soared during the pandemic, leaving time only for proper discharge cleaning between patients, the appearance of floors suffered as soil and detergent residues accumulated since rooms could not be taken offline for deep cleaning of floors. An innovative healthcare facility in the southeast recognized the result of its commitment to patient care had caused the appearance of its floors to suffer. Recognizing the need for a solution that would keep rooms open to maintain a high level of patient throughput while addressing the appearance of the LVT and resilient flooring in patient rooms, the facility turned to Contec and Square Scrub®.

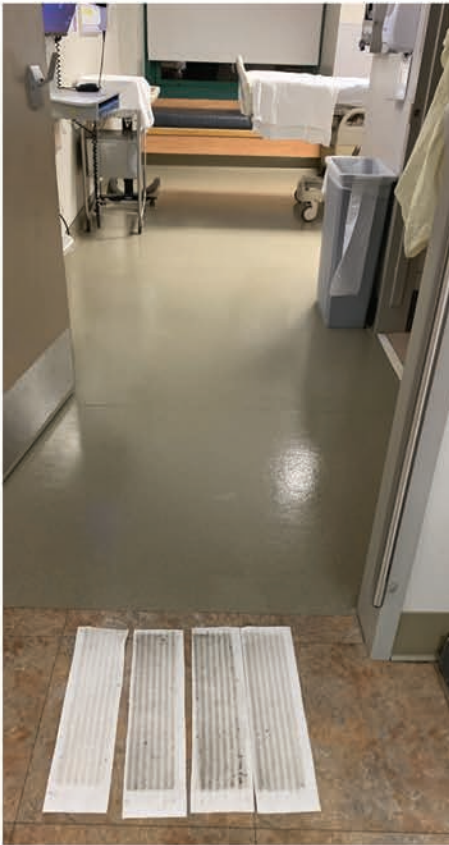

The solution to the challenge was pairing Contec's PREMIRA® single-use microfiber to trap and hold the soil in the texture of the flooring with the orbital action of the Square Scrub® Battery-Powered Doodle Mop®. By arming the discharge cleaning teams with this system, the hope was they could achieve a deep clean every discharge – resulting in a high-level appearance of the floor and the elimination of the need to block a room for deep cleaning.

This system was selected for testing due to the numerous benefits it provided the hospital:

- PREMIRA® single-use microfiber pads
 - Are perfect and fresh every time resulting in the highest level of soil recovery
 - Removes the need to be transported and laundered
 - Breaks any chain of potential infection since no other employees have to handle
 - Virtually eliminates any chance of cross-contamination
- Square Scrub® Battery-Powered Doodle Scrub®
 - Adds 4100 rpm of orbital cleaning action to the soil-trapping ability of the PREMIRA® single-use microfiber pad
 - Virtually eliminates any trip and fall potential with battery power

The hospital found outstanding results from the trial and put the system in place for all their discharge cleaning teams. Initially, anywhere from three to eight pads charged with a disinfectant/cleaner were being used in each room due to the amount of soil being recovered from the floors. However, after the initial cleaning, the appearance of the floors had been restored to an acceptable level. Subsequent cleanings required fewer pads and maintained the appearance level so that rooms would not have to be taken offline for intensive deep cleaning.





Case Study #2: Doodle Scrub® and Contec’s PREMIRA® Single-use Microfiber in Labs, Operating Rooms, Surgical Suites, and Labor & Delivery Suites

Another hospital in the southeast is employing the Doodle Mop® and the PREMIRA® Single-Use Microfiber Pads to solve both a cleaning and a labor challenge. In labor and delivery suites, operating rooms, surgical suites, and labs, cleaning technicians were cleaning all surfaces except the floor. Once the room was cleaned, they would contact a floor technician to bring an auto scrubber to clean the floor and finish the room.

This process presented several challenges. First, it interrupted the work of a floor technician who had to stop the work they were doing to clean the area they were summoned to clean. Second, the floor technician, bringing an auto scrubber into a perioperative/clean environment, would exhaust the soiled air from the recovery tank into the room. Third, the storage space needed to keep a dedicated auto scrubber in the unit was not available. The EVS manager described this as bringing a “mobile petri dish” into the room.

To address both of those challenges the hospital deployed Battery Powered Doodle Mops with PREMIRA® Single-Use Microfiber pads.

- They liked the fact the system provided the deep/terminal clean they needed without having any exhaust, making it the ideal tool for these floors.
- Using the charged PREMIRA® pads with a secondary use bottle of their disinfectant left the floors with enough moisture to meet the dwell time requirements for full efficacy.
- The Doodle Mop® was simple to operate and could be safely and effectively operated by the cleaning technicians, eliminating their need to call floor techs to finish the room.

The innovative partnership between Contec and Square Scrub® helps solve these and other floor cleaning challenges. For more information please contact your local representative.





Floor Finish Application Tool

18" Bucket on a Stick® - SS BOS18

24" Bucket on a Stick® - SS BOS24

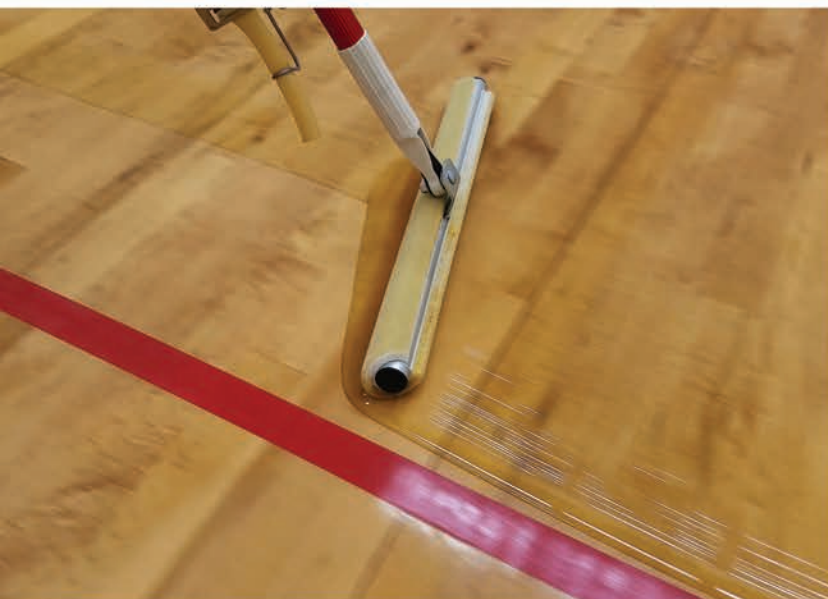



• Easy Release Handle

• New stronger and lighter weight fiberglass handle

• No drip clamping mechanism
• Straight hose for easy cleaning

18" Bucket on a Stick® - SS BOS18
24" Bucket on a Stick® - SS BOS24



18" Replacement Microfiber Mophead
SS 0403Z



24" Replacement Microfiber Mophead
SS 0406Z



18" T-bar Attachment - SS 0407Z

24" T-bar Attachment - SS 0411Z



18" T-bar Refill Pad - SS 0408Z

24" T-bar Refill Pad - SS 0412Z



Watch the Bucket on a Stick® video.

- The BOS simplifies the training process for new floor technicians, allowing them to apply even coats with little training.
- The drip-tube applicator evenly and efficiently applies floor finish, saving both time and money.
- The solution tank holds 5 quarts of liquid and will easily accommodate one gallon of floor finish at a time.

- The Bucket on a Stick® is non-proprietary, unlike many other systems, and will work with any floor finish.
- Unlike backpack systems, the Bucket on a Stick® is easy to clean and maintain.
- The Bucket on a Stick® uses parts that are easy to acquire, such as latex surgical tubing and bicycle cables, allowing you to quickly make any needed repairs. This is a great benefit when working over a weekend!

Healthcare



Patient Rooms

- Doodle Mop® - Most patient rooms have resilient sheet good floors or LVT. The Doodle Mop® helps maintain a high appearance level on these floors.
- Doodle Scrub® - The Doodle Scrub® is ideal for scrubbing tile & grout, as well as baseboards, in patient bathrooms.
- Pivot - When rubber or VCT flooring needs to be restored, a Pivot, Xtreme Sponge, and water can work wonders!



Surgical Suites

- Doodle Mop® - Paired with a Contec single-use microfiber cloth that is charged with a cleaner/disinfectant, the Doodle Mop® is an ideal final step for cleaning surgical suites, labor & delivery suites, and lab areas.



Lobby

- Pivot - The versatility of the Pivot makes it ideal for lobbies, which often have a variety of surfaces from VCT flooring to ceramic tile to carpet.
- Doodle Mop® - The Doodle Mop® is a great way to maintain a high level of appearance on floors in the lobby! Use with a Contec Premira® single-use microfiber cloth to avoid cross-contamination!



Patient Visit Rooms

- Doodle Mop® - Maintain clean floors between patients with the Doodle Mop® and a Contec Premira® pad!



Commercial Buildings

Bathrooms

- Doodle Scrub® - Ideal for cleaning under stall partitions, urinals, and sinks, and around & behind toilets, the Doodle Scrub® is a great way to keep bathrooms looking clean and smelling fresh!
- Pivot - Save time and clean large, open areas in bathrooms with the Pivot!



Elevators

- Battery Doodle Scrub® - The ideal way to clean in a small space that moves!
- Battery Doodle Mop® - Great for maintaining elevator floors without a cord.



Office Floors

- Doodle Mop® - "Scrub" under desks without moving them by using a Doodle Mop® and Contec Premira® pad!
- Pivot - Great for cleaning those wide-open spaces and hallways, the Pivot can clean and maintain any floor you come across, from LVT to carpet, to ceramic tile!



Break Rooms

- Doodle Mop® - The Doodle Mop® is great for maintaining the VCT, LVT, and ceramic tile often found in break rooms and kitchens.
- Doodle Scrub® & Pivot - The Pivot & Doodle Scrub® are perfect for deep cleaning floors in break rooms. If your breakroom has floor finish, these units allow you to easily top scrub and recoat the floor, saving time and money over traditional chemical stripping. However, if you want to chemical strip you can still do that with your Pivot and Doodle Scrub®, too!

Read about our success stories on the Case Studies page of our website! →





Education



Classrooms

- Doodle Mop® - Used regularly, the Doodle Mop® helps to maintain the appearance of LVT flooring in classrooms today.
- Doodle Scrub® - Ideal for tight spots that normally have to be cleaned manually.
- Pivot - The Pivot offers the ultimate in productivity and versatility! Any surface can be cleaned, maintained, or restored with the Pivot!



Bathrooms/Locker Rooms

- Pivot - Cleans ceramic tile floors found in school bathrooms and locker rooms.
- Doodle Scrub® - The Doodle Scrub® cleans under and behind toilets, under urinals, under sinks, under partitions, and into corners.



Stairs

- Doodle Scrub® - The battery powered Doodle Scrub® (BattScrub) is ideal for cleaning in stairwells since fire codes do not allow for outlets in stairwells. Use the Doodle Skate® to clean the stair risers!



Cafeteria

- Pivot - The Pivot is ideal for top-scrubbing and recoating floors in a large area like a cafeteria, saving labor dollars, stripper and finish costs every time! Also ideal for cleaning the tile and grout in the kitchen!
- Doodle Scrub® - Works alongside the Pivot in the kitchen to do tight spaces and low clearance areas.



Bus

- Doodle Mop® - Thoroughly clean the floors and aisle ways of school buses with the Doodle Mop® and a Contec Premira® pad!



Gymnasium

- Pivot - The Pivot is the fastest way to prepare a gym floor for recoating! The Pivot 28 has been documented at 10,000 square feet per hour preparing gym floors! As always, consult the directions provided by the manufacturer of the floor coating to determine steps for preparation.



Hotels

- Pivot - Can be used to clean tile and grout around pool decks, LVT flooring in dining areas, quarry tile in kitchens, and encapsulate carpet in hallways.
- Doodle Scrub® - Can be used to clean bathrooms floors, tile in showers, floors in bathroom stalls, and elevators.
- Doodle Mop® - The ideal solution for maintaining LVT flooring in rooms and other areas.



Food Service

- Pivot - Used to clean and restore floors in the dining areas and bathrooms, whether LVT, ceramic tile, or carpet.
- Doodle Scrub® - Ideal for cleaning and restoring floors under fixed tables and kitchen fixtures, in bathrooms, and in play areas.
- Doodle Mop® - Great for maintaining clean floors in dining rooms, bathrooms, and play areas.









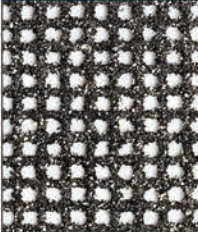

Manufacturing

- Pivot - Can be used to clean bathrooms, small carpeted areas in offices, non-slip floors, safety markings on floors covered with soil.
- Doodle Scrub® - Can be used to clean toilet stalls in bathrooms, single-person bathrooms, under and around manufacturing lines on the floor.
- Doodle Mop® - Can be used to maintain hard and resilient floors in break rooms, bathrooms, and offices.

Pad Name	Item Description	Product Number	Machine	Use Driver	QTY	Use Weights	Wet	Dry	Chemical
Drivers									
	Thin spacer pad used to protect the gripface when using abrasive pads, such as the SHO or SQP pads, as well as screens, sandpaper, and diamonds. With the pad being thin it transfers more of the orbital cleaning power to the floor.	SS P0511DRIVER	Doodle Scrub	No	48/Case	N/A		X	
		SS P1420DRIVER	Pivot 20	No	10/Case	Yes		X	
		SS P1428DRIVER	Pivot 28	No	10/Case	Yes		X	
	The blue pad can be used for light cleaning as well as a spacer pad.	SS P0511BLU	Doodle Scrub	No	18/Case	N/A	X		X
		SS P1420BLU	Pivot 20	No	5/Case	Yes	X		X
		SS P1428BLU	Pivot 28	No	5/Case	Yes	X		X
	The red pad can also be used for light cleaning as well as a spacer pad.	SS P1420RED	Pivot 20	No	5/Case	Yes	X		X
		SS P1428RED	Pivot 28	No	5/Case	Yes	X		X
VCT									
	Pad used for light cleaning particularly on high-gloss surfaces.	SS P0511WHT	Doodle Scrub	No	48/Case	N/A	X		
		SS P1420WHT	Pivot 20	No	10/Case	Yes	X		
		SS P1428WHT	Pivot 28	No	10/Case	Yes	X		
	Pad used in conjunction with a mop-down restorer on finished VCT floors.	SS P1420SSE	Pivot 20	No	5/Case		X		
		SS P1428SSE	Pivot 28	No	5/Case		X		
	Thin, abrasive pad used in the dry floor finish removal process. Always use in combination with the thin white spacer pad to protect the grip face.	SS P0511SQP	Doodle Scrub	Yes-1/4" White	60/case	N/A		X	
		SS P1420SQP	Pivot 20	Yes-1/4" White	10/Case	Yes		X	
		SS P1428SQP	Pivot 28	Yes-1/4" White	10/Case	Yes		X	
	Abrasive pad used to remove floor finish during the wet chemical stripping process.	SS P0511SHO	Doodle Scrub	Yes-1/4" White	20/case	N/A	X		X
		SS P1420SHO	Pivot 20	Yes-1/4" White	5/case	Yes	X		X
		SS P1428SHO	Pivot 28	Yes-1/4" White	5/Case	Yes	X		X
LVT, Tile & Grout, any floor with dimension									
	3D pad used for any surface with depth & dimension such as tile & grout, LVT, and rubberized safety flooring. The dense polypropylene fibers provide a deep clean without being abrasive.	SS P0511TGBV	Doodle Scrub	No	Each	N/A	X		
		SS P1420TGB	Pivot 20	No	Each	Yes	X		
		SS P1428TGB	Pivot 28	No	Each	Yes	X		
Rubberized Floors & Scuff Marks									
	Melamine pad for removing scuff marks and cleaning matte finish rubber floors.	SS P0511XTR	Doodle Scrub	No	5/Case	N/A	X		
		SS P0516XTR	Doodle Mop	No	5/Case	N/A	X		
		SS P1420XTR	Pivot 20	No	5/Case	Yes	X		
		SS P1428XTR	Pivot 28	No	5/Case	Yes	X		
Abrasion									
	Two-sided Carbide Tungsten Abrader Plate is the ideal tool for removing linoleum, glue, or even paint off of concrete. Always use with a Blue Driver pad and always use wet.	P1319SAP	Pivot 20	Yes-1" Blue or Red	Each	Standard - add weight as needed	X		
		P1327SAP	Pivot 28	Yes-1" Blue or Red	Each	Standard - add weight as needed	X		
Carpet									
	Microfiber pad used with an encapsulating cleaner on carpet. Encapsulant should be applied to both the pad and the carpet with a pump sprayer.	SS P1420CB	Pivot 20	No	Each	No	X		X
		SS P1428CB	Pivot 28	No	Each	No	X		X
Single-Use Microfiber									
	Single-use microfiber pad for use with the Doodle Mop	SS P0516DMF	Doodle Mop	No	240/Case	N/A	X		



Made in the USA

Pad Name	Item Description	Product Number	Machine	Use Driver	QTY	Use Weights	Wet	Dry	Chemical
Sandcreens									
	14 X 20 Sandcreens	60 grit sandscreen	SS S1420060	Pivot 20	Yes-1/4" White	10/Case	Yes		X
		80 grit sandscreen	SS S1420080		Yes-1/4" White	10/Case	Yes		X
		100 grit sandscreen	SS S1420100		Yes-1/4" White	10/Case	Yes		X
		120 grit sandscreen	SS S1420120		Yes-1/4" White	10/Case	Yes		X
		150 grit sandscreen	SS S1420150		Yes-1/4" White	10/Case	Yes		X
	14 X 28 Sandcreens	60 grit sandscreen	SS S14280060	Pivot 28	Yes-1/4" White	10/Case	Yes		X
		80 grit sandscreen	SS S1428080		Yes-1/4" White	10/Case	Yes		X
		100 grit sandscreen	SS S14280100		Yes-1/4" White	10/Case	Yes		X
		120 grit sandscreen	SS S14280120		Yes-1/4" White	10/Case	Yes		X
		150 grit sandscreen	SS S14280150		Yes-1/4" White	10/Case	Yes		X
Sandpaper									
	14 X 20 Sandpaper	20 Grit Sandpaper	SS SP1319020	Pivot 20	Yes-1/4" White	20/Case	Yes		X
		36 Grit Sandpaper	SS SP1319036		Yes-1/4" White	20/Case	Yes		X
		60 Grit Sandpaper	SS SP131960		Yes-1/4" White	20/Case	Yes		X
		80 Grit Sandpaper	SS SP1319080		Yes-1/4" White	20/Case	Yes		X
		100 Grit Sandpaper	SS SP1319100		Yes-1/4" White	20/Case	Yes		X
	14 x 28 Sandpaper	20 Grit Sandpaper	SS SP1327020	Pivot 28	Yes-1/4" White	20/Case	Yes		X
		36 Grit Sandpaper	SS SP1327036		Yes-1/4" White	20/Case	Yes		X
		60 Grit Sandpaper	SS SP132760		Yes-1/4" White	20/Case	Yes		X
		80 Grit Sandpaper	SS SP1327080		Yes-1/4" White	20/Case	Yes		X
		100 Grit Sandpaper	SS SP1327100		Yes-1/4" White	20/Case	Yes		X
Pro Sandpaper									
	14 X 20 Pro Sandpaper	24 Grit Pro Sandpaper - Double-sided	PPSP1319024	Pivot 20	Yes-1/4" White	10/Case	Yes		X
		36 Grit Pro Sandpaper - Double-sided	PPSP1319036		Yes-1/4" White	10/Case	Yes		X
		60 Grit Pro Sandpaper - Double-sided	PPSP1319060		Yes-1/4" White	10/Case	Yes		X
		80 Grit Pro Sandpaper - Double-sided	PPSP1319080		Yes-1/4" White	10/Case	Yes		X
		100 Grit Pro Sandpaper - Double-sided	PPSP1319100		Yes-1/4" White	10/Case	Yes		X
	14 x 28 Pro Sandpaper	24 Grit Pro Sandpaper - Double-sided	PPSP1327024	Pivot 28	Yes-1/4" White	10/Case	Yes		X
		36 Grit Pro Sandpaper - Double-sided	PPSP1327036		Yes-1/4" White	10/Case	Yes		X
		60 Grit Pro Sandpaper - Double-sided	PPSP1327060		Yes-1/4" White	10/Case	Yes		X
		80 Grit Pro Sandpaper - Double-sided	PPSP1327080		Yes-1/4" White	10/Case	Yes		X
		100 Grit Pro Sandpaper - Double-sided	PPSP1327100		Yes-1/4" White	10/Case	Yes		X
3M Trizact Diamond System									
	3M Trizact Diamond HX Pads	3.75 x 9 Coarse Trizact Diamond HX	SS TZD GOLD	Pivot 20, 28 and Doodle Scrub	Yes-1/4" White	Each	Follow Instructions Carefully	X	
		3.75 x 9 Medium Trizact Diamond HX	SS TZRED		Yes-1/4" White	Each		X	
		3.75 x 9 Fine Trizact Diamond HX	SS TZBLUE		Yes-1/4" White	Each		X	
	3M Scotch-Brite Purple Diamond Pads	Used for polishing stone floors that have been protected with 3M Scotchguard Stone Floor Protector	SS P0511PD	Doodle Scrub	No	5/Case	N/A		X
			SS P1420PD	Pivot 20	No	5/Case	Yes		X
			SS P1428PD	Pivot 28	No	5/Case	Yes		X

Applying a Driver Pad and an Abrasive Pad

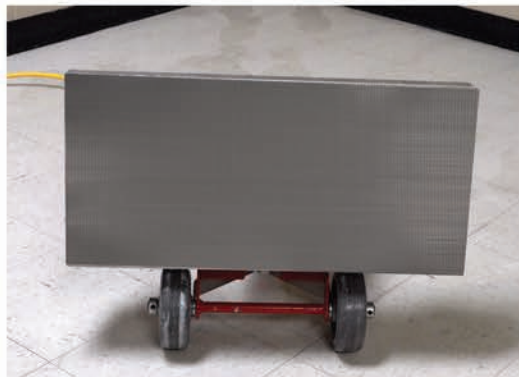

Tilt the machine on it's back. Always have a pad on the machine to protect the grip face.



Place the pad onto the grip face.



Place the pad against the wall, then tilt the machine back and place it on the pad.

There are two basic types of ceramic tile found in commercial spaces today.



Glazed Tile - These tiles are easier to maintain due to their impermeable, glassy surface. Unless the surface is etched or cracked anything on this surface should be relatively easy to clean.



Unglazed Tile - The surface of an unglazed tile can be porous and hold soil, but is often sealed in some manner for protection. They have a matte appearance as compared to glazed tile.

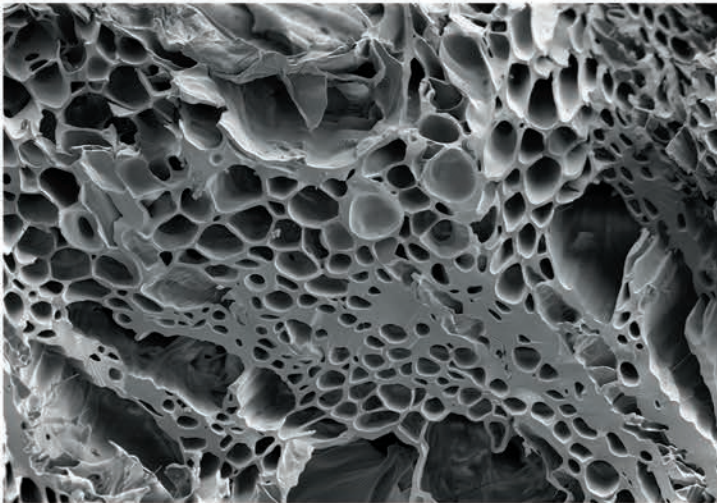

Far and away, the most difficult aspect of cleaning and maintaining ceramic tile floors is the grout between the tiles. A mixture of sand and cement, grout is porous, creating a perfect spot for soils to be trapped and stored.



Why tile & grout is difficult to maintain



Cleaning Tile & Grout with a Square Scrub Pivot

Another factor is grout lines are low spots on the floor to which detergent, water, and soil flow during the cleaning process. This mixture creates a biofilm that can not only be difficult to remove but harbor germs as well.



Close up photo of biofilm build-up in a grout line.



After cleaning with a Doodle Scrub[®] and 3D Blue Scrub Pad.

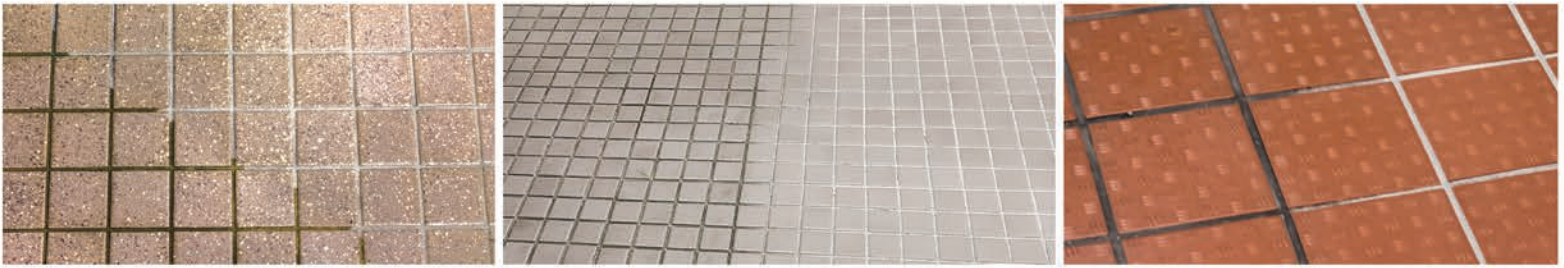

Doodle Scrub®
SS EBG-9



SS EBG-20/C PIVOT



SS EBG-28 PIVOT

3D Blue Scrub Pads

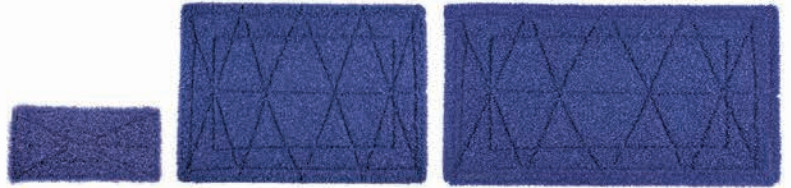

Doodle Scrub®
SS P0511TGBV

EBG-20/C PIVOT
SS P1420TGB

EBG-28 PIVOT
SS P1428TGB

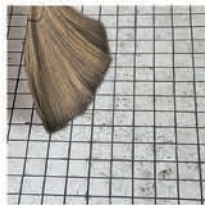

1. Sweep or vacuum to remove dry soil.

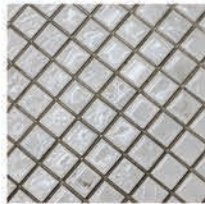

2. Mop down water or neutral cleaner to the area to be cleaned.



3. Apply 3D Blue Tile & Grout Pad to the Pivot or Doodle Scrub®.



4. Work back & forth in an East/West and North/South direction with the machine.



5. Recover the slurry from the floor with a mop or wet/dry vacuum.

How it Works

Biofilm Build-Up in Grout

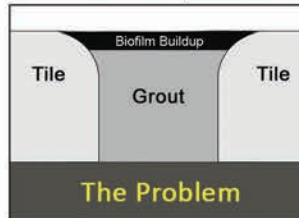

The Problem

Add Water/Cleaner

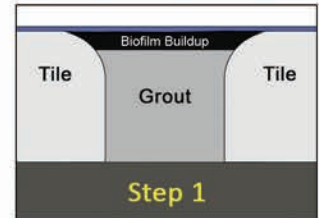

Step 1

Clean with 3D Scrub Pad

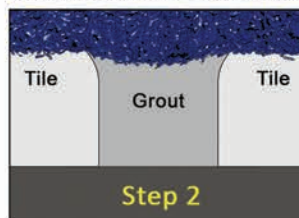

Step 2

Cleaned Grout Lines

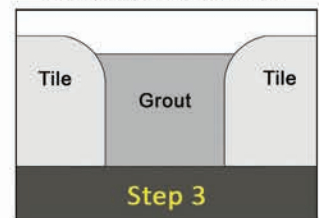

Step 3

For more information:



Cleaning Tile & Grout



Restoring and maintaining
tile & grout

LVT, or Luxury Vinyl, is a floor that has rapidly grown in popularity, quadrupling in square feet installed from 1.2 billion in 2015 to a projection of 4.8 billion in 2020.

This floor contains 4 layers:

- Vinyl foundation
- Photo image of the floor
- Plastic protective sheet
- UV-cured ceramic coating

- 1 Ceramic Bead Overlay**
Microscopic ceramic particles suspended in a clear urethane coating for providing wear resistance.
- 2 Clear Vinyl Wear Layer**
Provides significant durability against scuffs and abrasions.
- 3 Decorative Pattern**
Printed film delivers the realism of natural wood.
- 4 Solid Vinyl Core Layers**
Multiple layers of solid vinyl pressed together to form the core.

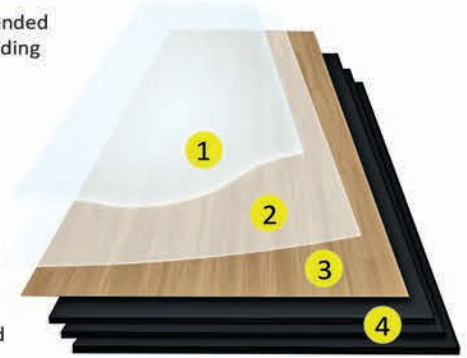

The challenge for cleaning technicians comes after the floor is put together and it is stamped or embossed with a pattern to resemble the grain or wood or texture the manufacturer wants the floor to have. These embossed areas create a low spot where solution from the cleaning process naturally runs to, leaving behind a sticky residue of detergent and soil after it evaporates. Generally, these patterns are very fine and are not effectively cleaned by pads or brushes since they cannot get down into the texture of the floor. This results in floors looking dull and dirty from the soil buildup.

The solution is the 3D Blue Tile & Grout Pad used on either the Square Scrub Pivot in large, open areas, or on the Doodle Scrub[®] in small, congested areas. The 3D Blue Tile & Grout Pad is designed for any surface that has dimension to it, such as LVT, tile & grout, or rubberized safety flooring.



The 3D Blue
Tile & Grout Pad
Video



Doodle Scrub[®]
SS P0511TGBV



EBG-20/C Pivot
SS P1420TGB



EBG-28 Pivot
SS P1428TGB

The polypropylene fibers of the 3D Blue Tile & Grout Pad do a fantastic job of gently digging out the soil and detergent residue from the texture of the floor.

The pad is not abrasive and will not damage the flooring.

Here is a series of videos that explains the following:



LVT
Construction
& the Challenge



LVT
Restoration
w/ 3D Blue Pad



LVT
Maintenance
once they are clean

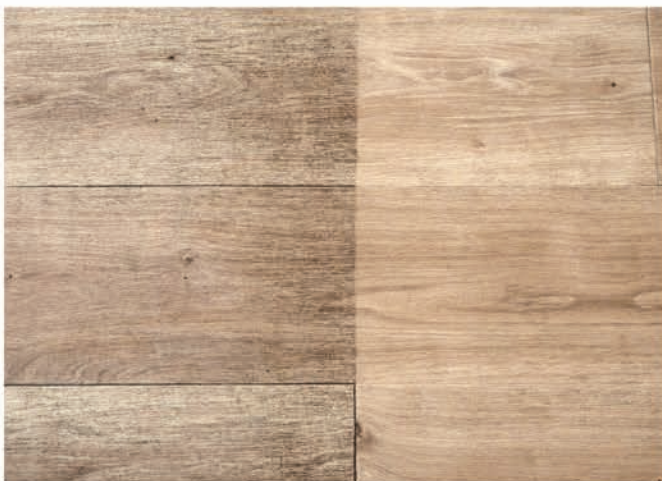

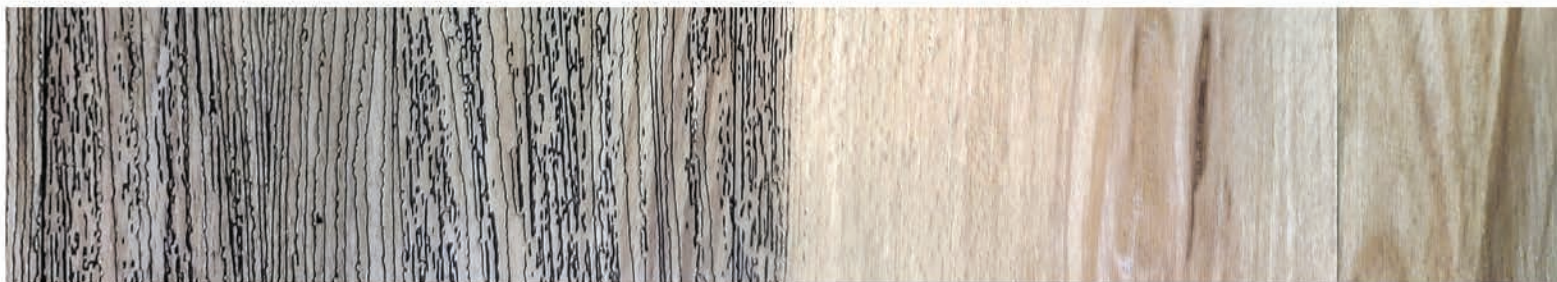

The Restoration Process for LVT The Maintenance Process for LVT

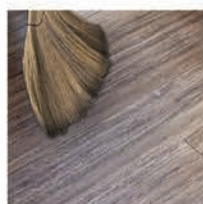

1. Sweep or vacuum the floor to remove dry soil.

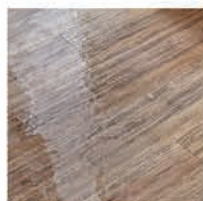

2. Mop down water or neutral cleaner to the area to be cleaned.



3. Apply 3D Blue Tile & Grout Pad to the Pivot or Doodle Scrub®.



4. Work back & forth in an East/West and North/South direction with the machine.



5. Recover the slurry from the floor with a mop or wet/dry vacuum.



1. Sweep or vacuum to remove dry soil.



2. Place wet-floor signs in appropriate locations.



3. Apply water or manufacturer-approved cleaning solution to the microfiber pad.



4. Work back & forth in an East/West and North/South direction with the Doodle Mop®.



5. Check pad frequently and change out as needed. When finished, dispose of used microfiber pad.



VCT Dry-Stripping - VCT, or Vinyl Composite Tile, floors are designed to have a protective coating of floor finish applied to them that takes the wear and tear from foot traffic while being easy to refresh. While most VCT floors are protected by four to six thin coats of floor finish, the damage caused by foot traffic is found in the top one or two coats. Dry stripping abrades the damaged coats of finish away, leaving undamaged floor finish intact on the floor. After abrasion, the remaining finish can be removed and new finish can be put down. This saves significant time, labor, and chemical costs over standard chemical stripping procedures.

Tools Needed:



SS EBG-20/C PIVOT

SS EBG-28 PIVOT



1/4" White Driver

EBG-20/C PIVOT
SS P1420DRIVER
EBG-28 PIVOT
SS P1428DRIVER



Blue Driver

EBG-20/C PIVOT
SS P1420BLU
EBG-28 PIVOT
SS P1428BLU



SQP Pad

EBG-20/C PIVOT
SS P1420SQP
EBG-28 PIVOT
SS P1428SQP



HEPA Dry Vac Kit
SS EBG-HDVK



Dust Skirt

EBG-20/C PIVOT
SS 142005
EBG-28 PIVOT
SS 142805

1. Sweep the floor to remove dry soils.
2. Prepare the Pivot for dry-stripping.



Prepare the Pivot
for Dry Stripping

1. Attach dust skirt to velcro around the base of the Pivot.
2. Install vacuum.
3. Plug vacuum into the block between the power cord and the motor.
4. Turn the power switch on the vacuum on so it powers on with the motor.

3. Apply a backer pad to protect the grip face of the Pivot or Doodle Scrub[®].
 - The White Driver Pad is recommended because the thin profile transfers more orbital action to the floor.
 - For uneven floors, one or two Blue or Red pads can be used to address low spots.
4. Apply SQP Pad to the backer pad
5. Cover the floor in long passes with a small overlap
6. SQP pads will cover approximately 300-400 square feet before they need to be flipped or exchanged
7. Vacuum, scrub, or mop the floor to remove the larger particles of pulverized finish on the floor
8. Once the floor is dry and no residue is found when wiping fingers across it, the floor is ready for new layers of finish



How to Install
a HEPA Vac



Dust Skirt
Installation



VCT
Dry Stripping



Dry-strip vs
Chemical Strip
Calculator



VCT Chemical Stripping - Chemical stripping is performed when all the finish on a floor must be completely removed. In this process, a chemical is used to break the bonds between the polymers in the finish for removal. Performing chemical stripping with the Square Scrub® Pivot is much safer than a low-speed machine since the small orbital pattern barely moves the machine when compared to the rapid movement right or left of the low-speed.

Tools Needed:

Follow finish manufacturers' direction for application of floor stripper.



SS EBG-20/C PIVOT

SS EBG-28 PIVOT



1/4" White Driver

EBG-20/C PIVOT
SS P1420DRIVER

EBG-28 PIVOT
SS P1428DRIVER



Blue Driver

EBG-20/C PIVOT
SS P1420BLU

EBG-28 PIVOT
SS P1428BLU



SHO Pad

EBG-20/C PIVOT
SS P1420SHO

EBG-28 PIVOT
SS P1428SHO

Videos to watch:



Pivot Safety



Chemical Stripping
with the Pivot

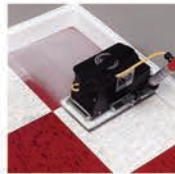

1. Apply a Blue Driver Pad for uneven floors. If the floor is extremely uneven apply two Blue Driver Pads.

2. Apply SHO Pad with a white Driver Pad.

3. Work into the area where the stripper has been applied and take long, overlapping passes.

4. Use the square corners of the Pivot to scrub in corners.

5. Use the Doodle Scrub® with the same driver and SHO pad set-up to scrub along edges and into other small spaces.

6. Follow standard stripping procedures to keep the slurry from drying, recover the slurry, and ensure the floor is ready for floor finish to be applied.

7. Once the floor is dry and no residue is found when wiping fingers across it, the floor is ready for new layers of finish. Use the Square Scrub® Bucket on a Stick® for fast application of floor finish and easy clean-up!

Rubber Flooring (Xtreme Sponge)



Rubber Flooring (Xtreme Sponge) - Rubber flooring is popular in emergency rooms, operating suites, offices, and other areas where seams and edges in flooring could harbor bacteria. Rubber flooring has a smooth surface, making the Xtreme Sponge by Square Scrub® the perfect choice for keeping floors clean.



The Xtreme Sponge is a melamine pad that uses only water and the orbital action of the Pivot, Doodle Mop®, or Doodle Scrub® to remove soil from rubber surfaces and restore their appearance!





Made in the USA

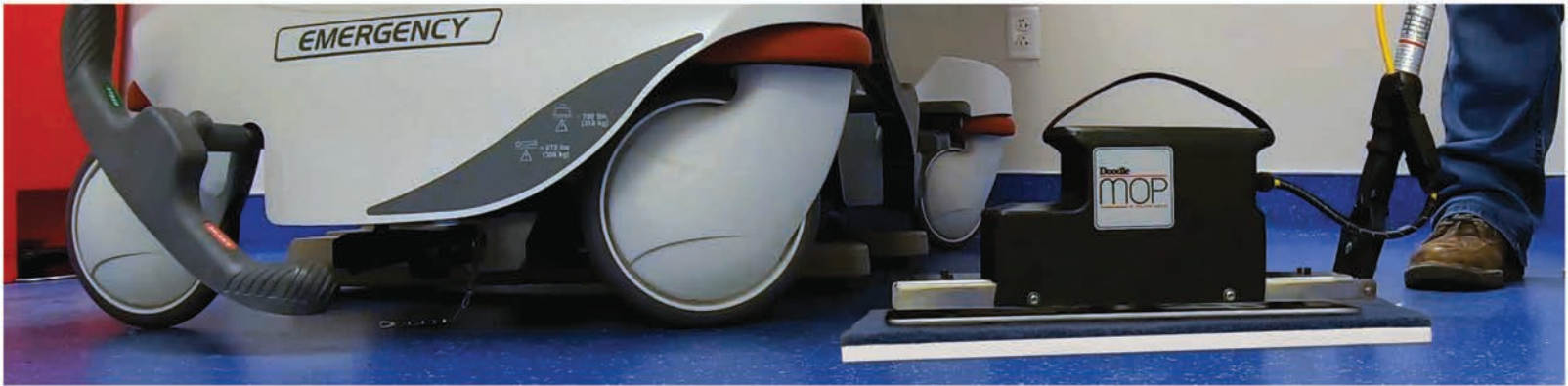

Tools Needed:



Xtreme Sponge Pads Showing top and bottom of the pad.



1. Completely saturate the Xtreme Sponge with water.



2. Apply Xtreme Sponge to the grip face



3. Run the Pivot in long overlapping passes over the floor.



4. Keep ample water on the floor so the pad stays saturated and does not come apart.





Encapsulating Carpet Cleaner - One Gal.
SS EBG-ECC

Interim maintenance procedures on the carpet, such as encapsulation cleaning, use less water, detergent, and labor than restorative methods such as hot water extraction. Additionally, encapsulation dries in 30 minutes as compared to 4 to 8 hours for extraction cleaning, returning the space to use much faster.

Because encapsulation uses far less water than extraction, spots do not wick back to the surface after cleaning. In fact, if you were to extract 1,000 square feet of carpet you would use 8 gallons of water and 16 to 24 ounces of detergent. To encapsulate the same 1,000 square feet of carpet would only require 1 gallon of water and 8 ounces of detergent!

Encapsulation works by separating the oily, sticky soils from the carpet fiber through detergent action. Once the soils are separated, the detergent dries to a flaky, non-sticky crystal around the soil. The soil can be recovered as soon as the carpet is dry in 30 minutes, though most simply recover it during the next scheduled vacuuming.



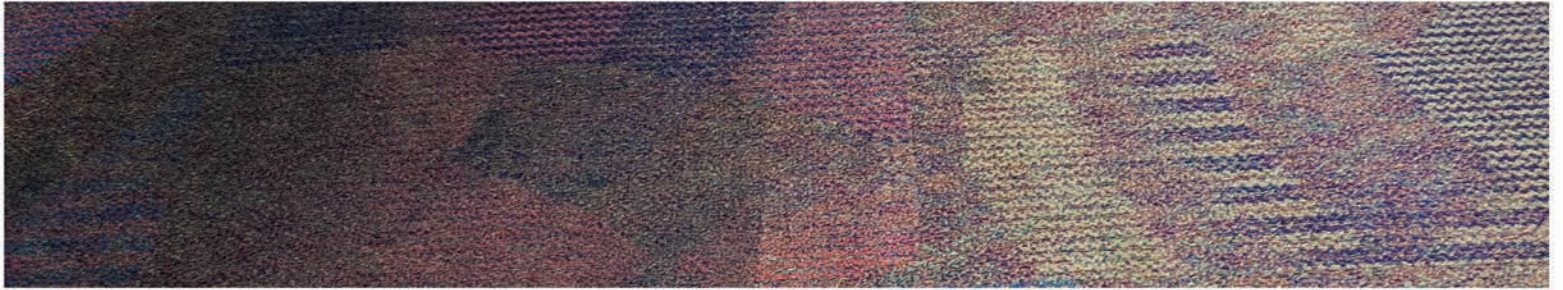

Tools Needed:



SS EBG-20/C PIVOT



SS EBG-28 PIVOT



Microfiber Carpet Pad
SS EBG-20/C PIVOT - SS P1420CB

Microfiber Carpet Pad
SS EBG-28 PIVOT - SS P1428CB



Encapsulating Carpet Cleaner
SS EBG-ECC



Pump Sprayer

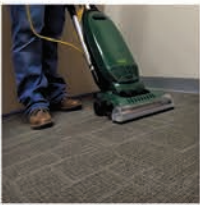

1. Vacuum the carpet thoroughly.



5. Begin cleaning, moving the machine forward, making long, overlapping passes like a lawnmower.



2. Mix encapsulant according to the manufacturers' directions in a pump-up or electric sprayer.



6. When you come to spots that need extra agitation, work them east-west and north-south, cross-hatching the area.

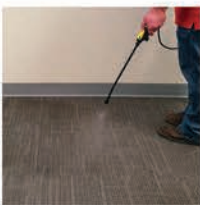

3. Pre-spray a small area to be cleaned, such as a 10x10 or 12x12 area, applying more encapsulation detergent to conspicuous or obvious spots.



7. Check the Microfiber Carpet Pad when pre-spraying a new area. Check for soil loading and flip or replace as needed.



4. Tip the Pivot back and apply the Microfiber Carpet Pad and saturate it by spraying it with the sprayer.

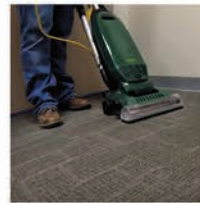

8. After the area is cleaned, recover the encapsulated soil when the carpet is dry or at the next scheduled vacuuming.

Sandscreen



20" PIVOT - Grits 60 to 150
28" PIVOT - Grits 60 to 180

SQP Pad



20" PIVOT - SS P1420SQP
28" PIVOT - SS P1428SQP

Maintaining a high level of appearance on gym floors can be a difficult task. Before beginning any work on the finish of a gym floor it is critical to consult the manufacturer of the coating on the floor for their recommendations on how to prepare the finish for recoating. Most manufacturers recommend using a surface preparation pad on water-based coatings, while most recommend using sand screens on an oil-based coating.

With either method, the Square Scrub[®] Pivot provides superior results and incredible productivity! The Square Scrub[®] Pivot 28 can prepare gym floors at an amazing 10,000 square feet per hour! The ¼ inch orbit of the Pivot does not leave the swirl marks commonly associated with low-speed machines.



Square Scrub[®] suggests screening gym floors diagonally across the floor with the Pivot. This helps to mitigate issues with low spots on the floor, which could be encountered if machines are operated lengthwise along the floor.

Tools Needed:



SS EBG-20/C PIVOT



SS EBG-28 PIVOT



1/4" White Driver

EBG-20/C PIVOT
SS P1420DRIVER

EBG-28 PIVOT
SS P1428DRIVER



SQP Pad

EBG-20/C PIVOT
SS P1420SQP

EBG-28 PIVOT
SS P1428SQP



Red Driver

EBG-20/C PIVOT
SS P1420RED

EBG-28 PIVOT
SS P1428RED



Sandscreen

EBG-20/C PIVOT
Grits - 60 to 150

EBG-28 PIVOT
Grits - 60 to 180



HEPA Dry Vac Kit
SS EBG-HDVK



EBG-20/C PIVOT
SS 142005

EBG-28 PIVOT
SS 142805

As stated previously, always consult the finish manufacturer for their recommendations for preparing the floor for recoating. Here are instructions for two of the most popular methods manufacturers recommend.

Gym Floor Preparation with a Surface Preparation Pad or Sand Screen

1. Consult the manufacturer's recommendations to ensure they recommend the use of a surface preparation pad for refinishing.
2. Sweep floor to remove any fine debris.
3. Tilt the Pivot onto its back and apply the 1/4" White Driver Pad to the grip face.
4. Apply an SQP Pad or a Sand Screen, depending on the manufacturer's recommendations, onto the White Driver Pad by laying it against the wall and then lowering the Pivot and White Driver Pad onto it.
5. Make long passes diagonally across the gym floor, overlapping as needed.
6. Refer to the finish manufacturer's recommendations for how many square feet to cover with each side of the SQP pad before flipping or changing.

Preparing your Pivot for Dry Gym Floor preparation



1. Ensure the dust skirt is properly installed around the base of the Pivot, bloused out to touch the floor, and attached in the back of the Pivot.

← Watch the "Dust Skirt Installation" video



2. Install the HEPA Vacuum to the Pivot, plug the hose into the port in the back of the base, and plug the power cord into the block installed between the power cord and the motor.

← Watch the "How to Install a HEPA Vac" video

3. Turn on the HEPA Vacuum so it powers on with the motor.



Sanding Wood Floors - Refreshing and restoring wood floors bring life back to their appearance! This process can be accomplished using a variety of tools, but the safest method is using an orbital scrubber.

Standard & Pro Sandpaper - There are two types of sandpaper that can be used with the Square Scrub® Pivot on wood floors. Standard sandpaper has one side that can be used while professional sandpaper has two sides.



Pro Sandpaper



Standard Sandpaper

Tools Needed:



SS EBG-20/C PIVOT



SS EBG-28 PIVOT



1/4" White Driver

EBG-20/C PIVOT
SS P1420DRIVER

EBG-28 PIVOT
SS P1428DRIVER



Sandpaper

EBG-20/C PIVOT
Standard Sandpaper - 20 to 100 Grit
Pro Sandpaper - 24 to 100 Grit
EBG-28 PIVOT
Standard Sandpaper - 20 to 100 Grit
Pro Sandpaper - 24 to 100 Grit



HEPA Dry Vac Kit
SS EBG-HDVK



Dust Skirt

EBG-20/C PIVOT
SS 142005

EBG-28 PIVOT
SS 142805



1. Make sure the floor is swept or vacuumed free of debris.

2. Apply a White Driver Pad to the grip face to protect it from the abrasive sandpaper.

3. Set the machine onto the sandpaper.

4. The square footage you will get out of each piece of sandpaper will vary greatly depending on a variety of factors, not the least of which is the type of wood you are sanding. Pay close attention to how the sandpaper is cutting and change or flip it when the results dictate.

5. Vacuum and tack mop the floor before applying stain or finish.



How to Install
a HEPA Vac



Dust Skirt
Installation



Wood Floor
Sanding



Sanding a
Wood Deck



Baseboards on tile floors tend to get dirty from mops slapping against them, depositing soils and detergent residues into the porous grout lines. Baseboards along VCT floors with floor finish can have mop residue along with floor finish and an accumulation of overspray from detergents.

All of these situations make baseboard cleaning imperative to provide your facility with a high level of appearance. Clean floors next to dirty baseboards make the job look unfinished. The challenge is scrubbing the baseboards by hand, which is back-breaking and tiresome work! Stair risers get dirty in a similar fashion as baseboards due to mopping but also add scuffing and kicking of shoes which can be difficult to manually remove.



The solution to cleaning baseboards and stair risers is the Doodle Skate[®]! An accessory that pairs with the Doodle Scrub[®], the Doodle Skate[®] allows the orbital cleaning power of the Doodle Scrub[®] to be turned 90 degrees to power-scrub these difficult-to-clean areas!



Tools Needed:



3D Blue Scrub Pad
SS P0511TGBV



Blue Driver Pad
SS P0511BLU



SHO Wet Strip Pad
SS P0511SHO



Doodle Skate[®]
Baseboard Cleaning
Video



1. Prepare for cleaning by applying the Doodle Skate[®] to the Doodle Scrub[®]. See page 18 for instructions on how to do this.

2. Apply any detergents you wish to use to the surface.

3. Run the Doodle Skate[®] along the surface to power-scrub the baseboard or stair riser!



Removing mastic and glue when updating flooring can be a time-intensive process if manual scraping is required.



The Square Scrub[®] Pivot and the SAP, Square Abrader Plate, can save hours by adding the orbital cleaning power of the Pivot! The Carbide Tungsten tips of the Square Abrader Plate make quick work of linoleum, glue, or paint on floors!

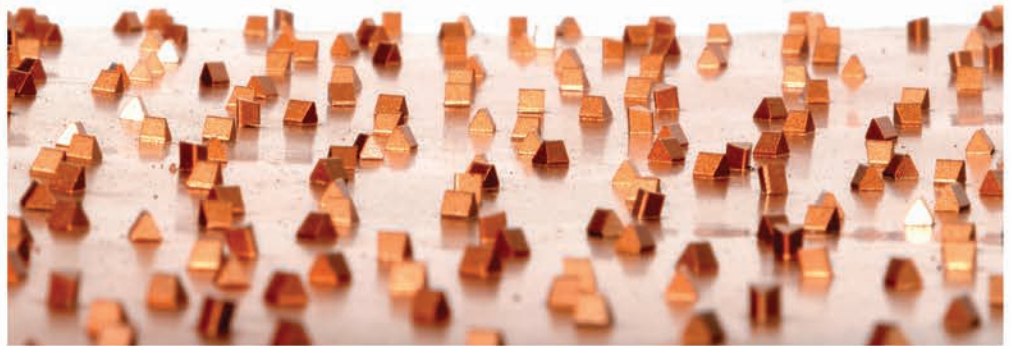

SAP (SQUARE ABRADER PLATE)
SS P1319SAP

Tools Needed:



SS EBG-20/C PIVOT



Blue Driver Pad
SS P1420BLU



SAP (SQUARE ABRADER PLATE)
SS P1319SAP



How to use an
Abrader Plate



Construction
Cleanup

1. Apply the Blue Driver Pad to the grip face of the Pivot.
2. Lay the Square Abrader Plate against a wall and tilt the Pivot onto it.
3. The floor's surface can be wet or dry when using the Abrader Plate. Check the driver pad frequently, replace as needed
4. Sweep up or use a wet/dry vacuum to recover the abraded material from the floor.

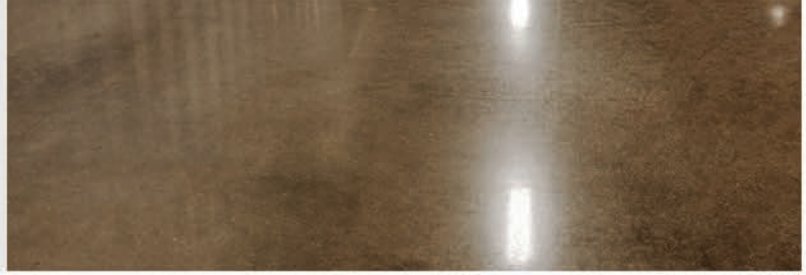

3M TRIZACT™ TZ Diamond Abrasive Strips

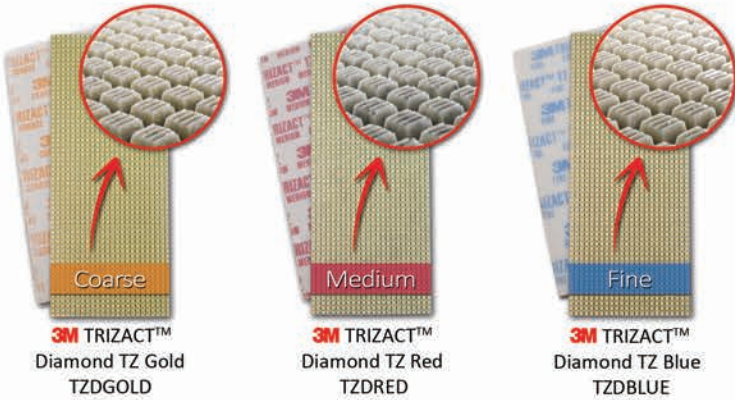

3M Scotch-Brite™ Purple Diamond Floor Pad Plus



3M Scotchgard™ Stone Floor Protector



Maintaining the appearance of concrete and terrazzo is easy with the Square Scrub Pivot® and the 3M Trizact System! Typical concrete and terrazzo polishing processes involve working through many grits of polishing diamonds to close the pores of the floor and restore the gloss. However, the Square Scrub® Pivot and the 3M Trizact System is designed with only three steps of diamond polishing and a Stone Protector to seal and protect the stone.



Polished Concrete Floors - These floors have grown in popularity due to their matte finish and ability to stand up to heavy amounts of foot traffic. The concrete is typically treated with a product to harden or densify the surface and then polished to the desired gloss level. However, over time the gloss level will degrade due to traffic on the floor and require polishing to restore it to the desired level.

Terrazzo - Another floor that has grown in popularity for its durability and design flexibility, terrazzo is a floor that requires occasional polishing to restore its gloss. Terrazzo floors are a mixture of colored chips made from marble, granite, quartz, glass, or other materials that are mixed with either epoxy or cement to bind the materials together and then poured in place. Once the floor has cured it is then polished to the desired level of gloss. Like concrete and stone, foot traffic eventually reduces the gloss level to a point restoration is required.



Tools Needed:



SS EBG-20/C PIVOT or
SS EBG-28 PIVOT



Doodle Scrub® Autoscrubber or
SS EBG-9 or Wet/Dry Vacuum
SS EBG-9-BAT



Solution Tank
SS EBG-20/C PIVOT
SS EBG-WTS20
SS EBG-28 PIVOT
SS EBG-WTS28
or a 5 gal bucket

**Bucket
on a Stick®**
18" BOS
SS BOS18
24" BOS
SS BOS24



1/4" White Driver
EBG-20/C PIVOT
SS P1420DRIVER
EBG-28 PIVOT
SS P1428DRIVER



3M Trizact TZ
Coarse - SS TZD GOLD
Medium - SS TZRED
Fine - SS TZBLUE



**3M Scotch-Brite
Purple Diamond
Pad Plus**
EBG-20/C PIVOT - SS P1420PD
EBG-28 PIVOT - SS P1428PD



**3M Scotchguard
Stone Floor
Protector**
SS SGSFP

1. Cover door frames and baseboards and put out wet floor signs.
2. Use a Square Scrub Pivot® and Blue Pad or an auto scrubber to clean the floor to prevent foreign debris from contaminating the process.
3. Attach the 3M Traizact TZ Coarse Diamonds in a staggered pattern to a clean White Driver Pad and place it on the grip face. Leave the standard weight stack on the Pivot.
4. Cover the area with water or apply water using the solution tank on the Square Scrub® Pivot. Always run the diamonds with plenty of water.
5. Operate the Square Scrub® Pivot at 1-foot per second, making three passes over the area, slightly overlapping each pass:
 1. North & South
 2. East & West
 3. Diagonally across the area
6. Use a wet/dry vacuum or an auto scrubber to vacuum the floor (do not engage the brushes on an auto scrubber) and prevent the coarse grits from contaminating the next set of diamonds.
7. Attach the 3M Traizact TZ Medium Diamonds in a staggered pattern to a clean White Driver Pad and place it on the grip face. Remove the weight stack from the Pivot.
8. Repeat the previous 3-pass process with the Medium Diamonds and then vacuum the floor with a wet/dry vacuum or an auto scrubber to prevent medium diamonds from contaminating the next set of diamonds.
9. Attach the 3M Trizact TZ Fine Diamonds in a staggered pattern to a clean White Driver Pad and place it on the grip face. Leave the weight stack off the Pivot.
10. Repeat the 3-pass process with the Fine Diamonds and then scrub or vacuum the floor to prevent medium diamonds from contaminating the next set of diamonds.
11. Vacuum the floor with a wet/dry vacuum or an auto scrubber before moving to the next step.
12. Make 3 passes with the Purple Diamond Pad Plus using either a Square Scrub® Pivot or a high-speed burnisher. Do not lay the purple Scotch-Brite pad on a dirty surface to avoid contamination. Once the darker purple layer is gone switch to a new pad.
13. Use the Bucket-on-a-Stick to apply Stone Protector to the floor. Saturate the pad with Stone Protector before applying it across the floor.
14. Allow the Stone Protector 15 to 20 minutes to dry and then repeat the 3-pass polishing step using the Square Scrub Pivot or high-speed burnisher.
15. Repeat the Stone Floor Protector application process.
16. Repeat the 3-pass Purple Diamond Pad Plus process.

Concrete Polishing with
3M Trizact Diamonds:
Case Study →



Diamond Strips can be set in rows of 2 or 3.



Fewer diamonds used = Cost effective



More diamonds used = Time saved

EBG-Series by Square Scrub®



Made in the USA



Doodle
MOP
BY SQUARE SCRUB

SS EBG-16
SS EBG-16-BAT



Doodle
SCRUB
BY SQUARE SCRUB

SS EBG-9
SS EBG-9-BAT



SQUARE
SCRUB
Versatility
PIVOT

SS EBG-20/C PIVOT
SS EBG-20C PVT 2PC
SS EBG-20/CV PIVOT
SS EBG-20CV PVT 2PC



SS EBG-28 PIVOT
SS EBG-28 PVT 2PC
SS EBG-28V PIVOT
SS EBG-28V PVT 2PC

Rental options available. Contact us for more information.

800-557-6822 | squarescrub.com



SQUARE
SCRUB
Versatility

Square Scrub®
P.O. Box 1693
Jonesboro, AR 72403



Order Catalogs

* specifications subject to change without notice ** patented or patent pending features may be shown
*** read manufacturers instructions for recommended floor maintenance procedures